



DEECOS

RECESSED PROJECTORS, SURFACE MOUNTED PROJECTORS
AND PENDANT LUMINAIRES





DEECOS

Recessed projectors, surface mounted projectors
and pendant luminaires

VERSATILE AND MULTI-TALENTED

An appealing lighting design is a must for successful sales in shops, museums or galleries. With the latest generation of DEECOS track spotlights, RZB offers a professional lighting solution, which sets the standard in terms of flexibility, performance and lighting design at the point of sale. RZB achieves this commitment to quality thanks to a modular system. This system allows a customised lighting solution to be configured to suit just about any presentation situation, with the maximum amount of attention being drawn to the product or exhibit.

The wide range of DEECOS accessories opens up plenty of options for additional fine tuning. The user-friendly bayonet connection allows the installation of accessories in seconds, without the need for any tools. Exchanging interchangeable lenses or heat-resistant plastic rings for suppressing glare from the side is child's play. Fitters will be delighted with the installation-friendly plug and play function of this multi-talented luminaire.

Thanks to the latest LED lighting technology, the DEECOS range does not require cooling ribs. The clear, modern and timeless cylinder design transforms the high-quality, die-cast aluminium housing into unobtrusive, yet attractive accessories, which stay discreetly in the background and reliably do their job with a service life of at least 50,000 hours.

Other members of the DEECOS family, which can be equipped with the same extensive range of optics and accessories, also include the built-on and recessed downlights Heledon, as well as the recessed spotlights Golas, Rondos and Magcardo.

ADDITIONAL ADVANTAGES

- ⊕ Excellent light quality thanks to flicker-free light, homogeneous light distribution, glare limitation and light colour quality
- ⊕ Suitable for reflector as well as lens technologies
- ⊕ MIRO-SILVER® reflectors for outstanding efficiency or polycarbonate lenses for the best uniformity of the light cone, each with three different beam angles narrow, medium, wide
- ⊕ Additional Superspot versions (recessed projecteurs and surface mounted projecteurs)
- ⊕ Additional light colours 927, 930, 935, 940 with Ra 95 and 832 with Ra 85 as well as for Maxi special food LEDs: champagne with Ra 97, meat and meat fresh available on request
- ⊕ High quality converter without flickering and stroboscopic effect
- ⊕ The following accessories can be mounted without use of tools: interchangeable lenses, decorative glasses, honeycomb louvre, clear and frosted diffusers, white interchangeable plastic ring





DEECOS

Overview



DEECOS R Mini
page 12



DEECOS S Mini Track-In
page 14-15



DEECOS S Mini
page 16-17



DEECOS S Maxi
page 18-19



DEECOS P Mini
page 20

DEECOS P Maxi
page 20

DEECOS Accessories
page 21

DEECOS

Technologie

EXCHANGEABLE-OPTICAL-SYSTEM

Depending on the requirements, the Exchangeable-Optical-System allows you to choose between the reflector/lens or change/replace it without tools later on.

MIRO-SILVER® reflectors for outstanding efficiency or polycarbonate lenses for the best uniformity of the light cone. In addition, opal decorative glasses are available as accessories for a diffuse spatial appearance.

- 3 different types of luminaires (recessed spotlight, surface-mounted spotlights, pendant spotlight)
- 2 sizes (mini and maxi)
- 2 optical systems (reflector and lens)
- 10 different light colors (830, 832, 840, 927, 930, 935, 940, Meat Fresh, Meat Plus, Champagne)
- 4 different beam angles with reflector
- 5 different beam angles with lens, also with corridor oval light distribution
- Additional Superspot versions
- Replaceable without tools

Tool-free installation:
honeycomb louvre, cover
or opal decorative glasses

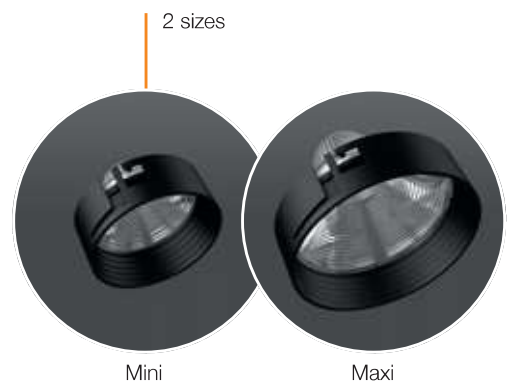

Tool-free assembly
with bayonet lock

Weitere Serien, die mit dem gleichen umfangreichen Optik- und Zubehörprogramm ausgestattet werden können:



HELEDON



RONDOS



GOLAS



MAGCARDO

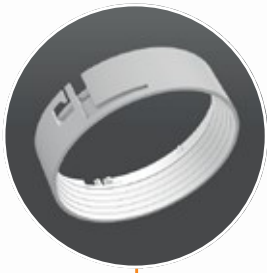

Thermo-resistant plastic ring black for lateral glare control or optional white



Additional superspot version with lens or reflector



Optical system reflector MIRO-SILVER® for excellent efficiency



Optic system lens polycarbonate for best homogeneity of the light cone



DEECOS

Everything at a glance



Easy installation with transparent and adjustable 2 m pendant cable and canopy with magnetic fixing



Inner cover prevents view into the false ceiling

Can be extended and retracted so that it is flush with the ceiling, turns by 356° and swivels by 90° for maximum flexibility in ad



2 sizes for surface mounted projecteurs and pendant luminaires:
Mini and Maxi



Tool-free installation:
Diffuser: mouth-blown opal glass, satin finish with bayonet lock

Also suitable for wall mounting with circuit tracks

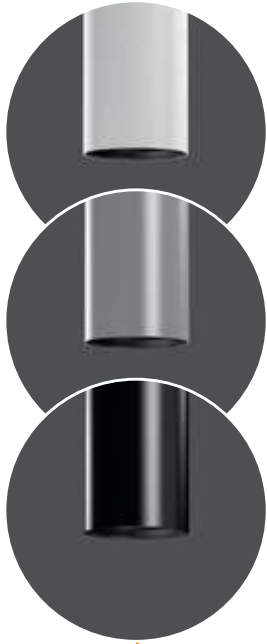

3 colours:
white, silver coloured or black

High quality die-cast aluminum housing



With multi-adapter for 3-circuit tracks, with adapter for RZB 3-circuit DALI tracks or with smart+free multi-adapter for 3-circuit tracks

Versions with smart+free Bluetooth® control for wireless network and operation using Android / iOS devices, free app available for download

PHOTOMETRICS

- ⊕ Luminous efficiency up to 131 lm/W
- ⊕ Luminaire flux from 1,700 to 4,400 lm
- ⊕ Colour temperature 3,000 K and 4,000 K, others on request
- ⊕ Colour rendering index Ra > 80, Ra > 90 options on request
- ⊕ Three different beam angles narrow, medium, wide - others can be realized with accessories
- ⊕ MIRO-SILVER® reflectors for outstanding efficiency
- ⊕ Polycarbonate lenses for the best uniformity of the light cone
- ⊕ LED rated life 50,000 h (L90, B10)
- ⊕ Good colour consistency within 2-steps MacAdam (2 SDCM)
- ⊕ Flicker free

DEECOS

Product overview | Recessed projectors



Recessed projectors | Deecos R Mini

Type of Protection: IP 20
 Protection Class: II
 Ceiling thickness: 1-20 mm
 Impact Protection: IK06

Housing: pressure die-cast aluminium, powder-coated. Rotation range: 356°. Swivel range: 90°. Can be swivelled flush with the ceiling. Heat resistant plastic ring black. Installation without tools thanks to spring fastening system. With optical assembly MIRO-SILVER® reflector or polycarbonate lens. Incl. separate LED converter with connecting cable 600 mm.

Available colours (X): 2 = white, 3 = black, 4 = silver coloured

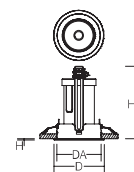

Comparison LED vs. conventional lamps

LED 19 / 20 W ≈
 1 x 35 W HIT (45 W Psys)

LED 29 W ≈
 1 x 50 W HIT (60 W Psys)



Accessories: Page 21

Reference number	Dimensions	Lamp	Light colour	Luminous flux	System power		dim-mable
Recessed projectors							
Ceiling cut out DA 133 mm							
Including lens for best uniformity of the light cone							
911467.00X	D 143, H 3, HE 210	LED	830	1950 lm	19 W	18°	on/off
911467.00X.76	D 143, H 3, HE 210	LED	830	1950 lm	19 W	18°	DALI
911468.00X	D 143, H 3, HE 210	LED	830	1850 lm	19 W	29°	on/off
911468.00X.76	D 143, H 3, HE 210	LED	830	1850 lm	19 W	29°	DALI
911469.00X	D 143, H 3, HE 210	LED	830	1700 lm	19 W	44°	on/off
911469.00X.76	D 143, H 3, HE 210	LED	830	1700 lm	19 W	44°	DALI
911467.00X.1	D 143, H 3, HE 210	LED	840	2050 lm	19 W	18°	on/off
911467.00X.1.76	D 143, H 3, HE 210	LED	840	2050 lm	19 W	18°	DALI
911468.00X.1	D 143, H 3, HE 210	LED	840	1950 lm	19 W	29°	on/off
911468.00X.1.76	D 143, H 3, HE 210	LED	840	1950 lm	19 W	29°	DALI
911469.00X.1	D 143, H 3, HE 210	LED	840	1800 lm	19 W	44°	on/off
911469.00X.1.76	D 143, H 3, HE 210	LED	840	1800 lm	19 W	44°	DALI
911473.00X	D 143, H 3, HE 210	LED	830	2800 lm	29 W	18°	on/off
911473.00X.76	D 143, H 3, HE 210	LED	830	2800 lm	29 W	18°	DALI
911474.00X	D 143, H 3, HE 210	LED	830	2650 lm	29 W	29°	on/off
911474.00X.76	D 143, H 3, HE 210	LED	830	2650 lm	29 W	29°	DALI
911475.00X	D 143, H 3, HE 210	LED	830	2450 lm	29 W	44°	on/off
911475.00X.76	D 143, H 3, HE 210	LED	830	2450 lm	29 W	44°	DALI
911473.00X.1	D 143, H 3, HE 210	LED	840	2950 lm	29 W	18°	on/off
911473.00X.1.76	D 143, H 3, HE 210	LED	840	2950 lm	29 W	18°	DALI
911474.00X.1	D 143, H 3, HE 210	LED	840	2800 lm	29 W	29°	on/off
911474.00X.1.76	D 143, H 3, HE 210	LED	840	2800 lm	29 W	29°	DALI
911475.00X.1	D 143, H 3, HE 210	LED	840	2550 lm	29 W	44°	on/off
911475.00X.1.76	D 143, H 3, HE 210	LED	840	2550 lm	29 W	44°	DALI
Including reflector for maximum efficiency							
911463.00X	D 143, H 3, HE 210	LED	830	2300 lm	19 W	17°	on/off
911463.00X.76	D 143, H 3, HE 210	LED	830	2300 lm	19 W	17°	DALI
911464.00X	D 143, H 3, HE 210	LED	830	2150 lm	19 W	32°	on/off
911464.00X.76	D 143, H 3, HE 210	LED	830	2150 lm	19 W	32°	DALI
911465.00X	D 143, H 3, HE 210	LED	830	2350 lm	19 W	62°	on/off
911465.00X.76	D 143, H 3, HE 210	LED	830	2350 lm	19 W	62°	DALI
911463.00X.1	D 143, H 3, HE 210	LED	840	2450 lm	19 W	17°	on/off
911463.00X.1.76	D 143, H 3, HE 210	LED	840	2450 lm	19 W	17°	DALI
911464.00X.1	D 143, H 3, HE 210	LED	840	2250 lm	19 W	32°	on/off
911464.00X.1.76	D 143, H 3, HE 210	LED	840	2250 lm	19 W	32°	DALI
911465.00X.1	D 143, H 3, HE 210	LED	840	2450 lm	19 W	62°	on/off
911465.00X.1.76	D 143, H 3, HE 210	LED	840	2450 lm	19 W	62°	DALI
911470.00X	D 143, H 3, HE 210	LED	830	3300 lm	29 W	17°	on/off
911470.00X.76	D 143, H 3, HE 210	LED	830	3300 lm	29 W	17°	DALI
911471.00X	D 143, H 3, HE 210	LED	830	3050 lm	29 W	32°	on/off
911471.00X.76	D 143, H 3, HE 210	LED	830	3050 lm	29 W	32°	DALI
911472.00X	D 143, H 3, HE 210	LED	830	3350 lm	29 W	62°	on/off
911472.00X.76	D 143, H 3, HE 210	LED	830	3350 lm	29 W	62°	DALI
911470.00X.1	D 143, H 3, HE 210	LED	840	3500 lm	29 W	17°	on/off
911470.00X.1.76	D 143, H 3, HE 210	LED	840	3500 lm	29 W	17°	DALI
911471.00X.1	D 143, H 3, HE 210	LED	840	3200 lm	29 W	32°	on/off
911471.00X.1.76	D 143, H 3, HE 210	LED	840	3200 lm	29 W	32°	DALI
911472.00X.1	D 143, H 3, HE 210	LED	840	3500 lm	29 W	62°	on/off
911472.00X.1.76	D 143, H 3, HE 210	LED	840	3500 lm	29 W	62°	DALI
Superspot version with small spot LED							
Including lens for best uniformity of the light cone							
911466.00X	D 143, H 3, HE 210	LED	830	1850 lm	20 W	14°	on/off
911466.00X.76	D 143, H 3, HE 210	LED	830	1850 lm	20 W	14°	DALI
911466.00X.1	D 143, H 3, HE 210	LED	840	1900 lm	20 W	14°	on/off
911466.00X.1.76	D 143, H 3, HE 210	LED	840	1900 lm	20 W	14°	DALI
Including reflector for maximum efficiency							
911462.00X	D 143, H 3, HE 210	LED	830	2100 lm	20 W	11°	on/off
911462.00X.76	D 143, H 3, HE 210	LED	830	2100 lm	20 W	11°	DALI
911462.00X.1	D 143, H 3, HE 210	LED	840	2200 lm	20 W	11°	on/off
911462.00X.1.76	D 143, H 3, HE 210	LED	840	2200 lm	20 W	11°	DALI

Versions with Ra > 90 colour rendition are also available in other light colours on request



DEECOS

Product overview | Surface mounted projectors



Surface mounted projectors | Deecos S Mini Track-In

Type of Protection: IP 20
 Protection Class: II
 Impact Protection: IK06

Housing: pressure die-cast aluminium, powder-coated. Rotation range: 356°. Swivel range: 90°. Heat resistant plastic ring black. With optical assembly MIRO-SILVER® reflector or polycarbonate lens. With multi-adaptor for 3-circuit tracks or with adapter for RZB 3-circuit DALI tracks. Converter integrated in the adapter. Ceiling and wall installation.

Available colours (X): 2 = white, 3 = black, 4 = silver coloured

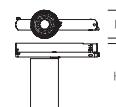

Comparison LED vs. conventional lamps

LED 19 / 20 W ≈
 1 x 35 W HIT (45 W Psys)

LED 29 W ≈
 1 x 50 W HIT (60 W Psys)

Reference number	Dimensions	Lamp	Light colour	Luminous flux	System power	Beam angle	dim-able
Surface mounted projector							
with multi adaptor for 3-circuit tracks 230 V							
Including lens for best uniformity of the light cone							
742102.00X	D 87, H 174	LED	830	1950 lm	19 W	18°	on/off
742103.00X	D 87, H 174	LED	830	1850 lm	19 W	29°	on/off
742104.00X	D 87, H 174	LED	830	1700 lm	19 W	44°	on/off
742102.00X.1	D 87, H 174	LED	840	2050 lm	19 W	18°	on/off
742103.00X.1	D 87, H 174	LED	840	1950 lm	19 W	29°	on/off
742104.00X.1	D 87, H 174	LED	840	1800 lm	19 W	44°	on/off
742108.00X	D 87, H 174	LED	830	2800 lm	29 W	18°	on/off
742109.00X	D 87, H 174	LED	830	2650 lm	29 W	29°	on/off
742110.00X	D 87, H 174	LED	830	2450 lm	29 W	44°	on/off
742108.00X.1	D 87, H 174	LED	840	2950 lm	29 W	18°	on/off
742109.00X.1	D 87, H 174	LED	840	2800 lm	29 W	29°	on/off
742110.00X.1	D 87, H 174	LED	840	2550 lm	29 W	44°	on/off
Including reflector for maximum efficiency							
742098.00X	D 87, H 174	LED	830	2300 lm	19 W	17°	on/off
742099.00X	D 87, H 174	LED	830	2150 lm	19 W	32°	on/off
742100.00X	D 87, H 174	LED	830	2350 lm	19 W	62°	on/off
742098.00X.1	D 87, H 174	LED	840	2450 lm	19 W	17°	on/off
742099.00X.1	D 87, H 174	LED	840	2250 lm	19 W	32°	on/off
742100.00X.1	D 87, H 174	LED	840	2450 lm	19 W	62°	on/off
742105.00X	D 87, H 174	LED	830	3300 lm	29 W	17°	on/off
742106.00X	D 87, H 174	LED	830	3050 lm	29 W	32°	on/off
742107.00X	D 87, H 174	LED	830	3350 lm	29 W	62°	on/off
742105.00X.1	D 87, H 174	LED	840	3500 lm	29 W	17°	on/off
742106.00X.1	D 87, H 174	LED	840	3200 lm	29 W	32°	on/off
742107.00X.1	D 87, H 174	LED	840	3500 lm	29 W	62°	on/off
Superspot version with small spot LED							
Including lens for best uniformity of the light cone							
742101.00X	D 87, H 174	LED	830	1850 lm	20 W	14°	on/off
742101.00X.1	D 87, H 174	LED	840	1900 lm	20 W	14°	on/off
Including reflector for maximum efficiency							
742097.00X	D 87, H 174	LED	830	2100 lm	20 W	11°	on/off
742097.00X.1	D 87, H 174	LED	840	2200 lm	20 W	11°	on/off

Versions with Ra > 90 colour rendition are also available in other light colours on request



Accessories: Page 21

Reference number	Dimensions	Lamp	Light colour	Luminous flux	System power		dimmi-able
Surface mounted projector							
Price Category 21							
with DALI adapter only for RZB 3-circuit DALI track 230 V							
Including lens for best uniformity of the light cone							
742114.00X.76	D 87, H 174	LED	830	2600 lm	26 W	18°	DALI
742115.00X.76	D 87, H 174	LED	830	2450 lm	26 W	29°	DALI
742116.00X.76	D 87, H 174	LED	830	2300 lm	26 W	44°	DALI
742114.00X.1.76	D 87, H 174	LED	840	2750 lm	26 W	18°	DALI
742115.00X.1.76	D 87, H 174	LED	840	2600 lm	26 W	29°	DALI
742116.00X.1.76	D 87, H 174	LED	840	2400 lm	26 W	44°	DALI
Including reflector for maximum efficiency							
742111.00X.76	D 87, H 174	LED	830	3100 lm	26 W	17°	DALI
742112.00X.76	D 87, H 174	LED	830	2850 lm	26 W	32°	DALI
742113.00X.76	D 87, H 174	LED	830	3150 lm	26 W	62°	DALI
742111.00X.1.76	D 87, H 174	LED	840	3250 lm	26 W	17°	DALI
742112.00X.1.76	D 87, H 174	LED	840	3000 lm	26 W	32°	DALI
742113.00X.1.76	D 87, H 174	LED	840	3300 lm	26 W	62°	DALI
Superspot version with small spot LED							
Including lens for best uniformity of the light cone							
742101.00X.76	D 87, H 174	LED	830	1850 lm	20 W	14°	DALI
742101.00X.1.76	D 87, H 174	LED	840	1900 lm	20 W	14°	DALI
Including reflector for maximum efficiency							
742097.00X.76	D 87, H 174	LED	830	2100 lm	20 W	11°	DALI
742097.00X.1.76	D 87, H 174	LED	840	2200 lm	20 W	11°	DALI

Versions with Ra > 90 colour rendition are also available in other light colours on request



Comparison LED vs. conventional lamps

LED 20 W ≈
1 x 35 W HIT (45 W Psys)

LED 26 W ≈
1 x 50 W HIT (60 W Psys)

Reference number	Dimensions	Lamp	Light colour	Luminous flux	System power		dimmi-able
Surface mounted projector							
Price Category 21							
With smart+free multi-adapter for 3-phase conductor rails 230 V							
Including lens for best uniformity of the light cone							
742114.00X.730	D 87, H 174	LED	830	2600 lm	26 W	18°	smart+free
742115.00X.730	D 87, H 174	LED	830	2450 lm	26 W	29°	smart+free
742116.00X.730	D 87, H 174	LED	830	2300 lm	26 W	44°	smart+free
742114.00X.1.730	D 87, H 174	LED	840	2750 lm	26 W	18°	smart+free
742115.00X.1.730	D 87, H 174	LED	840	2600 lm	26 W	29°	smart+free
742116.00X.1.730	D 87, H 174	LED	840	2400 lm	26 W	44°	smart+free
Including reflector for maximum efficiency							
742111.00X.730	D 87, H 174	LED	830	3100 lm	26 W	17°	smart+free
742112.00X.730	D 87, H 174	LED	830	2850 lm	26 W	32°	smart+free
742113.00X.730	D 87, H 174	LED	830	3150 lm	26 W	62°	smart+free
742111.00X.1.730	D 87, H 174	LED	840	3250 lm	26 W	17°	smart+free
742112.00X.1.730	D 87, H 174	LED	840	3000 lm	26 W	32°	smart+free
742113.00X.1.730	D 87, H 174	LED	840	3300 lm	26 W	62°	smart+free
Superspot version with small spot LED							
Including lens for best uniformity of the light cone							
742101.00X.730	D 87, H 174	LED	830	1850 lm	20 W	14°	smart+free
742101.00X.1.730	D 87, H 174	LED	840	1900 lm	20 W	14°	smart+free
Including reflector for maximum efficiency							
742097.00X.730	D 87, H 174	LED	830	2100 lm	20 W	11°	smart+free
742097.00X.1.730	D 87, H 174	LED	840	2200 lm	20 W	11°	smart+free

Versions with Ra > 90 colour rendition are also available in other light colours on request



Comparison LED vs. conventional lamps

LED 20 W ≈
1 x 35 W HIT (45 W Psys)

LED 26 W ≈
1 x 50 W HIT (60 W Psys)

DEECOS

Product overview | Surface mounted projectors



Surface mounted projectors | Deecos S Mini

Type of Protection: IP 20
 Protection Class: I
 Impact Protection: IK06

Housing: pressure die-cast aluminium, powder-coated. Rotation range: 356°. Swivel range: 90°. Heat resistant plastic ring black. With optical assembly MIRO-SILVER® reflector or polycarbonate lens. With multi-adapter for 3-circuit tracks or with adapter for RZB 3-circuit DALI tracks. Ceiling mounting.

Available colours (X): 2 = white, 3 = black, 4 = silver coloured

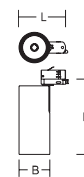

Comparison LED vs. conventional lamps

LED 19 / 20 W ≈
 1 x 35 W HIT (45 W Psys)

LED 29 W ≈
 1 x 50 W HIT (60 W Psys)

Reference number	Dimensions	Lamp	Light colour	Luminous flux	System power		dim-able
Surface mounted projector							
with multi adaptor for 3-circuit tracks 230 V							
Including lens for best uniformity of the light cone							
742019.00X	L 97, B 87, H 214	LED	830	1950 lm	19 W	18°	on/off
742020.00X	L 97, B 87, H 214	LED	830	1850 lm	19 W	29°	on/off
742021.00X	L 97, B 87, H 214	LED	830	1700 lm	19 W	44°	on/off
742019.00X.1	L 97, B 87, H 214	LED	840	2050 lm	19 W	18°	on/off
742020.00X.1	L 97, B 87, H 214	LED	840	1950 lm	19 W	29°	on/off
742021.00X.1	L 97, B 87, H 214	LED	840	1800 lm	19 W	44°	on/off
742025.00X	L 97, B 87, H 214	LED	830	2800 lm	29 W	18°	on/off
742026.00X	L 97, B 87, H 214	LED	830	2650 lm	29 W	29°	on/off
742027.00X	L 97, B 87, H 214	LED	830	2450 lm	29 W	44°	on/off
742025.00X.1	L 97, B 87, H 214	LED	840	2950 lm	29 W	18°	on/off
742026.00X.1	L 97, B 87, H 214	LED	840	2800 lm	29 W	29°	on/off
742027.00X.1	L 97, B 87, H 214	LED	840	2550 lm	29 W	44°	on/off
Including reflector for maximum efficiency							
742015.00X	L 97, B 87, H 214	LED	830	2300 lm	19 W	17°	on/off
742016.00X	L 97, B 87, H 214	LED	830	2150 lm	19 W	32°	on/off
742017.00X	L 97, B 87, H 214	LED	830	2350 lm	19 W	62°	on/off
742015.00X.1	L 97, B 87, H 214	LED	840	2450 lm	19 W	17°	on/off
742016.00X.1	L 97, B 87, H 214	LED	840	2250 lm	19 W	32°	on/off
742017.00X.1	L 97, B 87, H 214	LED	840	2450 lm	19 W	62°	on/off
742022.00X	L 97, B 87, H 214	LED	830	3300 lm	29 W	17°	on/off
742023.00X	L 97, B 87, H 214	LED	830	3050 lm	29 W	32°	on/off
742024.00X	L 97, B 87, H 214	LED	830	3350 lm	29 W	62°	on/off
742022.00X.1	L 97, B 87, H 214	LED	840	3500 lm	29 W	17°	on/off
742023.00X.1	L 97, B 87, H 214	LED	840	3200 lm	29 W	32°	on/off
742024.00X.1	L 97, B 87, H 214	LED	840	3500 lm	29 W	62°	on/off
Superspot version with small spot LED							
Including lens for best uniformity of the light cone							
742018.00X	L 97, B 87, H 214	LED	830	1850 lm	20 W	14°	on/off
742018.00X.1	L 97, B 87, H 214	LED	840	1900 lm	20 W	14°	on/off
Including reflector for maximum efficiency							
742014.00X	L 97, B 87, H 214	LED	830	2100 lm	20 W	11°	on/off
742014.00X.1	L 97, B 87, H 214	LED	840	2200 lm	20 W	11°	on/off

Versions with Ra > 90 colour rendition are also available in other light colours on request



Accessories: Page 21

Reference number	Dimensions	Lamp	Light colour	Luminous flux	System power		dimmable
Surface mounted projector							
Price Category 21							
with DALI adapter only for RZB 3-circuit DALI track 230 V							
Including lens for best uniformity of the light cone							
742019.00X.76	L 97, B 87, H 214	LED	830	1950 lm	19 W	18°	DALI
742020.00X.76	L 97, B 87, H 214	LED	830	1850 lm	19 W	29°	DALI
742021.00X.76	L 97, B 87, H 214	LED	830	1700 lm	19 W	44°	DALI
742019.00X.1.76	L 97, B 87, H 214	LED	840	2050 lm	19 W	18°	DALI
742020.00X.1.76	L 97, B 87, H 214	LED	840	1950 lm	19 W	29°	DALI
742021.00X.1.76	L 97, B 87, H 214	LED	840	1800 lm	19 W	44°	DALI
742025.00X.76	L 97, B 87, H 214	LED	830	2800 lm	29 W	18°	DALI
742026.00X.76	L 97, B 87, H 214	LED	830	2650 lm	29 W	29°	DALI
742027.00X.76	L 97, B 87, H 214	LED	830	2450 lm	29 W	44°	DALI
742025.00X.1.76	L 97, B 87, H 214	LED	840	2950 lm	29 W	18°	DALI
742026.00X.1.76	L 97, B 87, H 214	LED	840	2800 lm	29 W	29°	DALI
742027.00X.1.76	L 97, B 87, H 214	LED	840	2550 lm	29 W	44°	DALI
Including reflector for maximum efficiency							
742015.00X.76	L 97, B 87, H 214	LED	830	2300 lm	19 W	17°	DALI
742016.00X.76	L 97, B 87, H 214	LED	830	2150 lm	19 W	32°	DALI
742017.00X.76	L 97, B 87, H 214	LED	830	2350 lm	19 W	62°	DALI
742015.00X.1.76	L 97, B 87, H 214	LED	840	2450 lm	19 W	17°	DALI
742016.00X.1.76	L 97, B 87, H 214	LED	840	2250 lm	19 W	32°	DALI
742017.00X.1.76	L 97, B 87, H 214	LED	840	2450 lm	19 W	62°	DALI
742022.00X.76	L 97, B 87, H 214	LED	830	3300 lm	29 W	17°	DALI
742023.00X.76	L 97, B 87, H 214	LED	830	3050 lm	29 W	32°	DALI
742024.00X.76	L 97, B 87, H 214	LED	830	3350 lm	29 W	62°	DALI
742022.00X.1.76	L 97, B 87, H 214	LED	840	3500 lm	29 W	17°	DALI
742023.00X.1.76	L 97, B 87, H 214	LED	840	3200 lm	29 W	32°	DALI
742024.00X.1.76	L 97, B 87, H 214	LED	840	3500 lm	29 W	62°	DALI
Superspot version with small spot LED							
Including lens for best uniformity of the light cone							
742018.00X.76	L 97, B 87, H 214	LED	830	1850 lm	20 W	14°	DALI
742018.00X.1.76	L 97, B 87, H 214	LED	840	1900 lm	20 W	14°	DALI
Including reflector for maximum efficiency							
742014.00X.76	L 97, B 87, H 214	LED	830	2100 lm	20 W	11°	DALI
742014.00X.1.76	L 97, B 87, H 214	LED	840	2200 lm	20 W	11°	DALI

Versions with Ra > 90 colour rendition are also available in other light colours on request



Comparison
LED vs. conventional lamps

LED 19 / 20 W ≈
1 x 35 W HIT (45 W Psys)

LED 29 W ≈
1 x 50 W HIT (60 W Psys)



Fig. with reflector



Fig. with lens



DEECOS

Product overview | Surface mounted projectors



Surface mounted projectors | Deecos S Maxi

Type of Protection: IP 20
 Protection Class: I
 Impact Protection: IK06

Housing: pressure die-cast aluminium, powder-coated. Rotation range: 356°. Swivel range: 90°. Heat resistant plastic ring black. With optical assembly MIRO-SILVER® reflector or polycarbonate lens. With multi-adapter for 3-circuit tracks or with adapter for RZB 3-circuit DALI tracks. Ceiling and wall installation.

Available colours (X): 2 = white, 3 = black, 4 = silver coloured

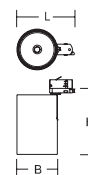

Comparison LED vs. conventional lamps

LED 20 / 24 W ≈
 1 x 35 W HIT (45 W Psys)

LED 37 W ≈
 1 x 50 W HIT (60 W Psys)

Reference number	Dimensions	Lamp	Light colour	Luminous flux	System power		dim-able
Surface mounted projector							
with multi adaptor for 3-circuit tracks 230 V							
Including lens for best uniformity of the light cone							
742005.00X	L 133, B 123, H 200	LED	830	2350 lm	24 W	12°	on/off
742006.00X	L 133, B 123, H 200	LED	830	2350 lm	24 W	29°	on/off
742007.00X	L 133, B 123, H 200	LED	830	2350 lm	24 W	41°	on/off
742005.00X.1	L 133, B 123, H 200	LED	840	2500 lm	24 W	12°	on/off
742006.00X.1	L 133, B 123, H 200	LED	840	2450 lm	24 W	29°	on/off
742007.00X.1	L 133, B 123, H 200	LED	840	2500 lm	24 W	41°	on/off
742011.00X	L 133, B 123, H 200	LED	830	3300 lm	37 W	12°	on/off
742012.00X	L 133, B 123, H 200	LED	830	3250 lm	37 W	29°	on/off
742013.00X	L 133, B 123, H 200	LED	830	3300 lm	37 W	41°	on/off
742011.00X.1	L 133, B 123, H 200	LED	840	3500 lm	37 W	12°	on/off
742012.00X.1	L 133, B 123, H 200	LED	840	3500 lm	37 W	29°	on/off
742013.00X.1	L 133, B 123, H 200	LED	840	3500 lm	37 W	41°	on/off
Including reflector for maximum efficiency							
742001.00X	L 133, B 123, H 200	LED	830	2850 lm	24 W	10°	on/off
742002.00X	L 133, B 123, H 200	LED	830	3000 lm	24 W	20°	on/off
742003.00X	L 133, B 123, H 200	LED	830	2900 lm	24 W	34°	on/off
742001.00X.1	L 133, B 123, H 200	LED	840	3000 lm	24 W	10°	on/off
742002.00X.1	L 133, B 123, H 200	LED	840	3150 lm	24 W	20°	on/off
742003.00X.1	L 133, B 123, H 200	LED	840	3050 lm	24 W	34°	on/off
742008.00X	L 133, B 123, H 200	LED	830	4000 lm	37 W	10°	on/off
742009.00X	L 133, B 123, H 200	LED	830	4200 lm	37 W	20°	on/off
742010.00X	L 133, B 123, H 200	LED	830	4050 lm	37 W	34°	on/off
742008.00X.1	L 133, B 123, H 200	LED	840	4200 lm	37 W	10°	on/off
742009.00X.1	L 133, B 123, H 200	LED	840	4400 lm	37 W	20°	on/off
742010.00X.1	L 133, B 123, H 200	LED	840	4250 lm	37 W	34°	on/off
Superspot version with small spot LED							
Including lens for best uniformity of the light cone							
742004.00X	L 133, B 123, H 200	LED	830	1750 lm	20 W	10°	on/off
742004.00X.1	L 133, B 123, H 200	LED	840	1800 lm	20 W	10°	on/off
Including reflector for maximum efficiency							
742000.00X	L 133, B 123, H 200	LED	830	2050 lm	20 W	7°	on/off
742000.00X.1	L 133, B 123, H 200	LED	840	2150 lm	20 W	7°	on/off

Versions with Ra > 90 colour rendition are also available in other light colours on request



Accessories: Page 21

Reference number	Dimensions	Lamp	Light colour	Luminous flux	System power		dim-able
Surface mounted projector							
with DALI adapter only for RZB 3-circuit DALI track 230 V							
Including lens for best uniformity of the light cone							
742005.00X.76	L 133, B 123, H 200	LED	830	2350 lm	24 W	12°	DALI
742006.00X.76	L 133, B 123, H 200	LED	830	2350 lm	24 W	29°	DALI
742007.00X.76	L 133, B 123, H 200	LED	830	2350 lm	24 W	41°	DALI
742005.00X.1.76	L 133, B 123, H 200	LED	840	2500 lm	24 W	12°	DALI
742006.00X.1.76	L 133, B 123, H 200	LED	840	2450 lm	24 W	29°	DALI
742007.00X.1.76	L 133, B 123, H 200	LED	840	2500 lm	24 W	41°	DALI
742011.00X.76	L 133, B 123, H 200	LED	830	3300 lm	37 W	12°	DALI
742012.00X.76	L 133, B 123, H 200	LED	830	3250 lm	37 W	29°	DALI
742013.00X.76	L 133, B 123, H 200	LED	830	3300 lm	37 W	41°	DALI
742011.00X.1.76	L 133, B 123, H 200	LED	840	3500 lm	37 W	12°	DALI
742012.00X.1.76	L 133, B 123, H 200	LED	840	3500 lm	37 W	29°	DALI
742013.00X.1.76	L 133, B 123, H 200	LED	840	3500 lm	37 W	41°	DALI
Including reflector for maximum efficiency							
742001.00X.76	L 133, B 123, H 200	LED	830	2850 lm	24 W	10°	DALI
742002.00X.76	L 133, B 123, H 200	LED	830	3000 lm	24 W	20°	DALI
742003.00X.76	L 133, B 123, H 200	LED	830	2900 lm	24 W	34°	DALI
742001.00X.1.76	L 133, B 123, H 200	LED	840	3000 lm	24 W	10°	DALI
742002.00X.1.76	L 133, B 123, H 200	LED	840	3150 lm	24 W	20°	DALI
742003.00X.1.76	L 133, B 123, H 200	LED	840	3050 lm	24 W	34°	DALI
742008.00X.76	L 133, B 123, H 200	LED	830	4000 lm	37 W	10°	DALI
742009.00X.76	L 133, B 123, H 200	LED	830	4200 lm	37 W	20°	DALI
742010.00X.76	L 133, B 123, H 200	LED	830	4050 lm	37 W	34°	DALI
742008.00X.1.76	L 133, B 123, H 200	LED	840	4200 lm	37 W	10°	DALI
742009.00X.1.76	L 133, B 123, H 200	LED	840	4400 lm	37 W	20°	DALI
742010.00X.1.76	L 133, B 123, H 200	LED	840	4250 lm	37 W	34°	DALI
Superspot version with small spot LED							
Including lens for best uniformity of the light cone							
742004.00X.76	L 133, B 123, H 200	LED	830	1750 lm	20 W	10°	DALI
742004.00X.1.76	L 133, B 123, H 200	LED	840	1800 lm	20 W	10°	DALI
Including reflector for maximum efficiency							
742000.00X.76	L 133, B 123, H 200	LED	830	2050 lm	20 W	7°	DALI
742000.00X.1.76	L 133, B 123, H 200	LED	840	2150 lm	20 W	7°	DALI

Versions with Ra > 90 colour rendition are also available in other light colours on request



Comparison LED vs. conventional lamps

LED 20 / 24 W ≈
1 x 35 W HIT (45 W Psys)

LED 37 W ≈
1 x 50 W HIT (60 W Psys)



Fig. with lens



Fig. with reflector



DEECOS

Product overview | Pendant luminaires



Pendant luminaires | Deecos P Mini

Type of Protection: IP 20
 Protection Class: I
 Impact Protection: IK06
 Suspension Length: 2000 mm

Housing: pressure die-cast aluminium, powder-coated. Heat resistant plastic ring black. With optical assembly MIRO-SILVER® reflector or polycarbonate lens. Transparent pendant cable 2 m, can be shortened, with integrated steel cable. Canopy made of powder-coated sheet steel with magnetic attachment.

Available colours (X): 2 = white, 3 = black, 4 = silver coloured

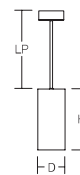

Comparison LED vs. conventional lamps

LED 19 W ≈
1 x 35 W HIT (45 W Psys)

LED 29 W ≈
1 x 50 W HIT (60 W Psys)

Reference number	Dimensions	Lamp	Light colour	Luminous flux	System power	α	UGR	dimmable
Pendant luminaires								
Including lens for best uniformity of the light cone								
911477.00X	D 87, H 195	LED	830	1700 lm	19 W	44°	16,0	on/off
911477.00X.76	D 87, H 195	LED	830	1700 lm	19 W	44°	16,0	DALI
911477.00X.1	D 87, H 195	LED	840	1800 lm	19 W	44°	16,2	on/off
911477.00X.1.76	D 87, H 195	LED	840	1800 lm	19 W	44°	16,2	DALI
911479.00X	D 87, H 195	LED	830	2450 lm	29 W	44°	17,3	on/off
911479.00X.76	D 87, H 195	LED	830	2450 lm	29 W	44°	17,3	DALI
911479.00X.1	D 87, H 195	LED	840	2550 lm	29 W	44°	17,5	on/off
911479.00X.1.76	D 87, H 195	LED	840	2550 lm	29 W	44°	17,5	DALI
Including reflector for maximum efficiency								
911476.00X	D 87, H 195	LED	830	2350 lm	19 W	62°	20,5	on/off
911476.00X.76	D 87, H 195	LED	830	2350 lm	19 W	62°	20,5	DALI
911476.00X.1	D 87, H 195	LED	840	2450 lm	19 W	62°	20,6	on/off
911476.00X.1.76	D 87, H 195	LED	840	2450 lm	19 W	62°	20,6	DALI
911478.00X	D 87, H 195	LED	830	3350 lm	29 W	62°	21,7	on/off
911478.00X.76	D 87, H 195	LED	830	3350 lm	29 W	62°	21,7	DALI
911478.00X.1	D 87, H 195	LED	840	3500 lm	29 W	62°	21,9	on/off
911478.00X.1.76	D 87, H 195	LED	840	3500 lm	29 W	62°	21,9	DALI

Ra > 90 options on request



Pendant luminaires | Deecos P Maxi

Type of Protection: IP 20
 Protection Class: I
 Impact Protection: IK06
 Suspension Length: 2000 mm

Housing: pressure die-cast aluminium, powder-coated. Heat resistant plastic ring black. With optical assembly MIRO-SILVER® reflector or polycarbonate lens. Transparent pendant cable 2 m, can be shortened, with integrated steel cable. Canopy made of powder-coated sheet steel with magnetic attachment.

Available colours (X): 2 = white, 3 = black, 4 = silver coloured

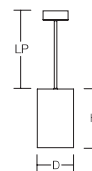

Comparison LED vs. conventional lamps

LED 37 W ≈
1 x 70 W HIT (84 W Psys)

Reference number	Dimensions	Lamp	Light colour	Luminous flux	System power	α	UGR	dimmable
Pendant luminaires								
Including lens for best uniformity of the light cone								
911481.00X	D 123, H 181	LED	830	3300 lm	37 W	41°	14,1	on/off
911481.00X.76	D 123, H 181	LED	830	3300 lm	37 W	41°	14,1	DALI
911481.00X.1	D 123, H 181	LED	840	3500 lm	37 W	41°	14,2	on/off
911481.00X.1.76	D 123, H 181	LED	840	3500 lm	37 W	41°	14,2	DALI
Including reflector for maximum efficiency								
911480.00X	D 123, H 181	LED	830	4050 lm	37 W	34°	15,0	on/off
911480.00X.76	D 123, H 181	LED	830	4050 lm	37 W	34°	15,0	DALI
911480.00X.1	D 123, H 181	LED	840	4250 lm	37 W	34°	15,2	on/off
911480.00X.1.76	D 123, H 181	LED	840	4250 lm	37 W	34°	15,2	DALI

Versions with Ra > 90 colour rendition are also available in other light colours on request



Accessories | Decorative recessed pendant set

Mounting kit for aesthetically pleasing ceiling connection of pendant luminaires.

Decorative recessed pendant set		
982572.002*	L 146, B 60, H 12, HE 80	Mounting kit for plasterboard ceilings
982571.009	L 180, B 148, H 124, HE 130	Mounting set for concrete ceilings
982570.009	L 180, B 180, H 124, HE 130	Mounting set for plastered concrete ceilings

* Not suitable for DALI version

Accessories for Deecos R Mini | Deecos S Mini | Deecos P Mini

Diffuser			Price Category 21
982370.000	D 74, H 3	Safety glass clear	
982370.010	D 74, H 3	Safety glass, satin finish	

Decorative glasses			Price Category 21
982647.002	D 87, H 41	Diffuser: mouth-blown opal glass, satin finish with bayonet lock.	
982648.002	D 87, H 76	Diffuser: mouth-blown opal glass, satin finish with bayonet lock.	



Anti-glare honeycomb louvre			Price Category 21
982371.003	D 74, H 3	Honeycomb louvre Mini	



Interchangeable plastic rings			Price Category 21
982419.002	D 82, H 20	White plastic ring for reflector	
982421.002	D 82, H 31	White plastic ring for lens	



Interchangeable optics			Price Category 21
982368.003	D 82, H 55	Reflector, narrow beam 17°	
982368.013	D 82, H 55	Reflector, medium beam 32°	
982368.033	D 82, H 55	Reflector, wide beam 62°	
982369.003	D 82, H 55	Lens, narrow beam 18°	
982369.013	D 82, H 55	Lens, medium beam 29°	
982369.023	D 82, H 55	Lens, wide beam 44°	
982369.033	D 82, H 55	Lens, very wide beam 70°	
982369.043	D 82, H 55	Lens with oval light distribution for corridor 28°/40°	



Accessories for Deecos S Maxi | Deecos P Maxi

Diffuser			Price Category 21
982374.000	D 111, H 3	Safety glass clear	
982374.010	D 111, H 3	Safety glass, satin finish	

Decorative glasses			Price Category 21
982649.002	D 123, H 41	Diffuser: mouth-blown opal glass, satin finish with bayonet lock	
982650.002	D 123, H 76	Diffuser: mouth-blown opal glass, satin finish with bayonet lock	



Anti-glare honeycomb louvre			Price Category 21
982375.003	D 111, H 3	Maxi honeycomb louvre	

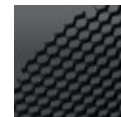

Interchangeable plastic rings			Price Category 21
982420.002	D 118, H 20	White plastic ring for reflector	
982422.002	D 118, H 33	White plastic ring for lens	



Interchangeable optics			Price Category 21
982372.003	D 118, H 83	Reflector, narrow beam 10°	
982372.013	D 118, H 83	Reflector, medium beam 20°	
982372.023	D 118, H 83	Reflector, wide beam 34°	
982372.033	D 118, H 83	Reflector, very wide beam 63°	
982373.003	D 118, H 83	Lens, narrow beam 12°	
982373.013	D 118, H 83	Lens, medium beam 29°	
982373.023	D 118, H 83	Lens, wide beam 41°	





WEITERE SERIEN MIT GLEICHEM EXCHANGEABLE-OPTICAL-SYSTEM



⊕ Heledon



⊕ Heledon



⊕ Rondos



⊕ Golas



⊕ Magcardo

HIGHEST PRODUCT AND CONSULTING QUALITY

⊕ RELIABILITY

We are your reliable partner. From the first idea to the implementation and far beyond, we accompany your project. Personal, passionate and individual. Thanks to our excellent expertise, top product quality and services such as lighting design, economic efficiency analysis and commissioning, we meet the high demands of all parties involved in the planning process.

- ✓ availability of BIM files
- ✓ easy and quick installation
- ✓ quality and long warranty

⊕ WARRANTY

RZB grants 5 years warranty on LED luminaires and 2 years warranty on emergency luminaires!

The creation of high quality lighting solutions is our passion. Our products are developed and manufactured with the utmost care.

In addition to SMART TECHNOLOGY and EXCELLENT DESIGN, we are dedicated to manufacture luminaires of highest quality throughout the entire value chain through to After Sales Service.

Because of this, we confidently grant you a 5 years warranty on LED luminaires and 2 years warranty on emergency luminaires with effect of the date of invoice without prior registration of your project.

Warranty terms to be found under

rzb.de/en/service/led-luminaire-warranty

RZB - FOR A TANGIBLE ADDED VALUE.



RZB
Rudolf Zimmermann,
Bamberg GmbH

Rheinstr. 16
96052 Bamberg
Germany

Phone +49 951/79 09-374
Fax +49 951/79 09-212

www.rzb-lighting.com
export@rzb.eu

