



TRIONA[®]

RECESSED CEILING, CEILING, WALL AND PENDANT LUMINAIRES
FOR INDOOR USE

TRIONA®

Recessed ceiling, ceiling, wall and pendant luminaires

LIGHT INNOVATION TO THE POWER OF 3

You take a naturally perfect shape like the circle and fill it with astonishingly even light...

the TRIONA recessed luminaire is a lighting tool that lives up to its name by setting new standards in three respects at the same time: visual function, biological effect and emotional light quality.

Ideal for use as part of a Human Centric Lighting (HCL) concept, the series includes versions with tunable white technology. This also makes it possible to generate dynamic lighting, with infinitely variable colour temperature and brightness, simulating the natural course of daylight.

This light-induced support for the human circadian rhythm has been proven to have a positive effect on people's wellbeing and performance. People living in retirement homes or hospitals can benefit in particular from this biological effect, as well as those in offices, conference rooms and classrooms.

In addition, TRIONA in itself generates extremely homogeneous, glare-free, powerful and yet soft light. This is thanks to the RZB SIDELITE® technology, which uses lateral light emission for the rimless illumination of the luminaire body. The series includes versions, which also emit indirect light through the top of the luminaire – ensuring impressive visual and design effects. Despite the additional light emission area, the sizeable top surface of the luminaire does not have any edges or depressions worth mentioning or any visible screws and is therefore quick and easy to clean.

The proportions of the luminaire, which comes in three different diameters, are also remarkable: the high-quality aluminium profile of the housing measures – for a luminaire diameter of up to a metre! – just 50mm, leaving the most space possible in the diffuser for light emission and effect.

Various diffuser versions, including a microprismatic version with $UGR \leq 19$ that is suitable for computer workstations, also expand TRIONA's potential for different applications. The 680mm version of the luminaire can even be enhanced with an elaborately crafted Ferro Murano glass insert, turning it into a unique and precious piece.

Three colours are available for the powder-coated housing. Special colours can also be made for further individualisation. TRIONA is suitable for ceiling and wall installation and is also available as a pendant version.

ADDITIONAL ADVANTAGES

- ⊕ Made in Germany
- ⊕ Ideal for office areas ($UGR \leq 19$) and environments with computer screens in accordance with EN 12464-1
- ⊕ **Lightguide** and **diffuser** made of **non-yellowing PMMA**
- ⊕ This lighting fixture's diffuser is incorporated in a **seamless** extruded aluminium profile just 50 mm thick
- ⊕ Hand-crafted FerroMurano glass inserts available in 3 different colours or an opal/micro-prismatic or an opal diffuser offer an enormous scope of design this distinctive large surface luminaire
- ⊕ Ideal for use as part of a Human Centric Lighting concept (HCL)
- ⊕ Versions with smart+free Bluetooth® control for wireless network and operation using Android/iOS devices, free app available for download





TRIONA®

HCL (Human Centric Lighting)



FEEL BETTER, BE MORE EFFICIENT

During evolution humans have developed a complex system of internal timers, the so-called circadian system by the perception of light and dark, cold and warm, as well as by the change of seasons, with daylight being the natural timer for this rhythm.

Only a few years ago scientists discovered in the eye's retina those cells which are not required for seeing, but are setting our internal timer by suppressing or distributing the hormone melatonin. Now chronobiologists, lighting designers and architects have the chance to decisively improve our living conditions by using dynamic light.

Biologically effective light in "tunable white" versions aims to support the hormone control process by simulating the light colour and intensity of the natural course of daylight.

Changing light moods in the dynamic rhythm of daylight can have an extremely positive influence on wellbeing.

Light management systems such as RZB light control +³ with the appropriate sensor technology can automatically regulate these processes. Versions with the RZB smart+free component allow personal access to light scenarios controlled by an app.



HEALTH

HCL strengthening the biological rhythm of human beings and fostering well-being and good health.



VITALITY

HCL creating a stimulating light to increase vitality and quality of life.



ACTIVITY

HCL increasing in educational institutions and workplaces the performance and ability of focusing.



WELL-BEING

HCL avoiding sleep disorder, stabilising patients in hospitals and nursing homes.



TRIONA®

Simply obvious



TRIONA - DYNAMIC LIGHT AT WORKPLACE

The individually programmed settings can be implemented in a timely manner and then can be intelligently and user-friendly called up. Characteristics such as lux level, light distribution, colour temperature and dynamics are decisive.





TRIONA®

Overview



Recessed ceiling luminaires
page 16-17

Ceiling and wall luminaires
page 18-21



Ceiling and wall luminaires
page 22



Pendant luminaires
page 24-27



Pendant luminaires
page 28-29

TRIONA[®]

Technology

Installation plate

Indirect light emission through **non-yellowing plastic (PMMA) diffuser**, satin finish.

Ideal for office areas (UGR ≤ 19) and environments with computer screens in accordance with EN 12464-1

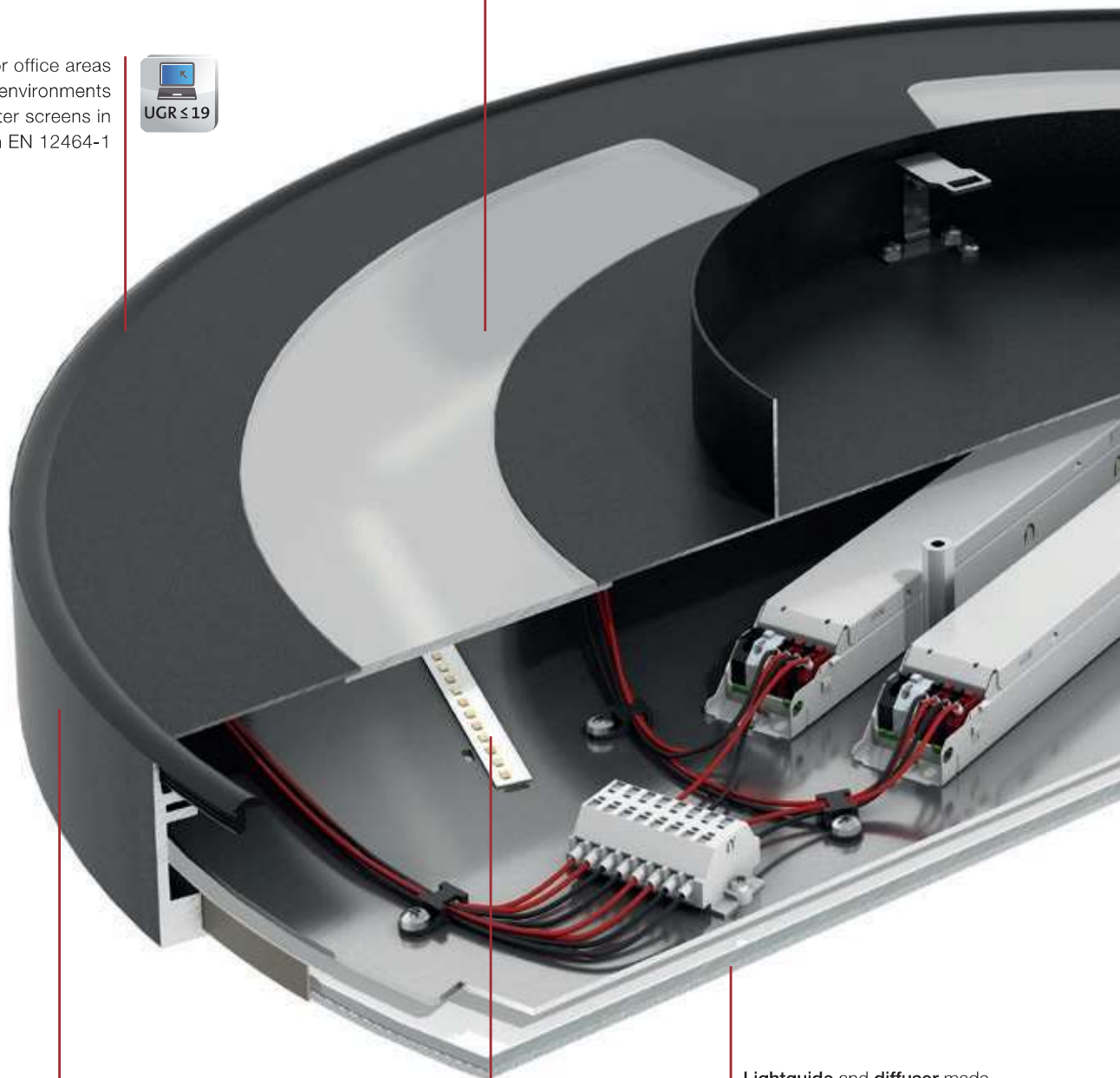

Lightguide and diffuser made of non-yellowing PMMA

3 different colours are available for the very flat and **seamless** extruded aluminium profile



LED for indirect light emission (830, 840, tunable white)



Very easy plug-in installation
(Quick connector)

Mounting without use of tools, with bayonet fitting

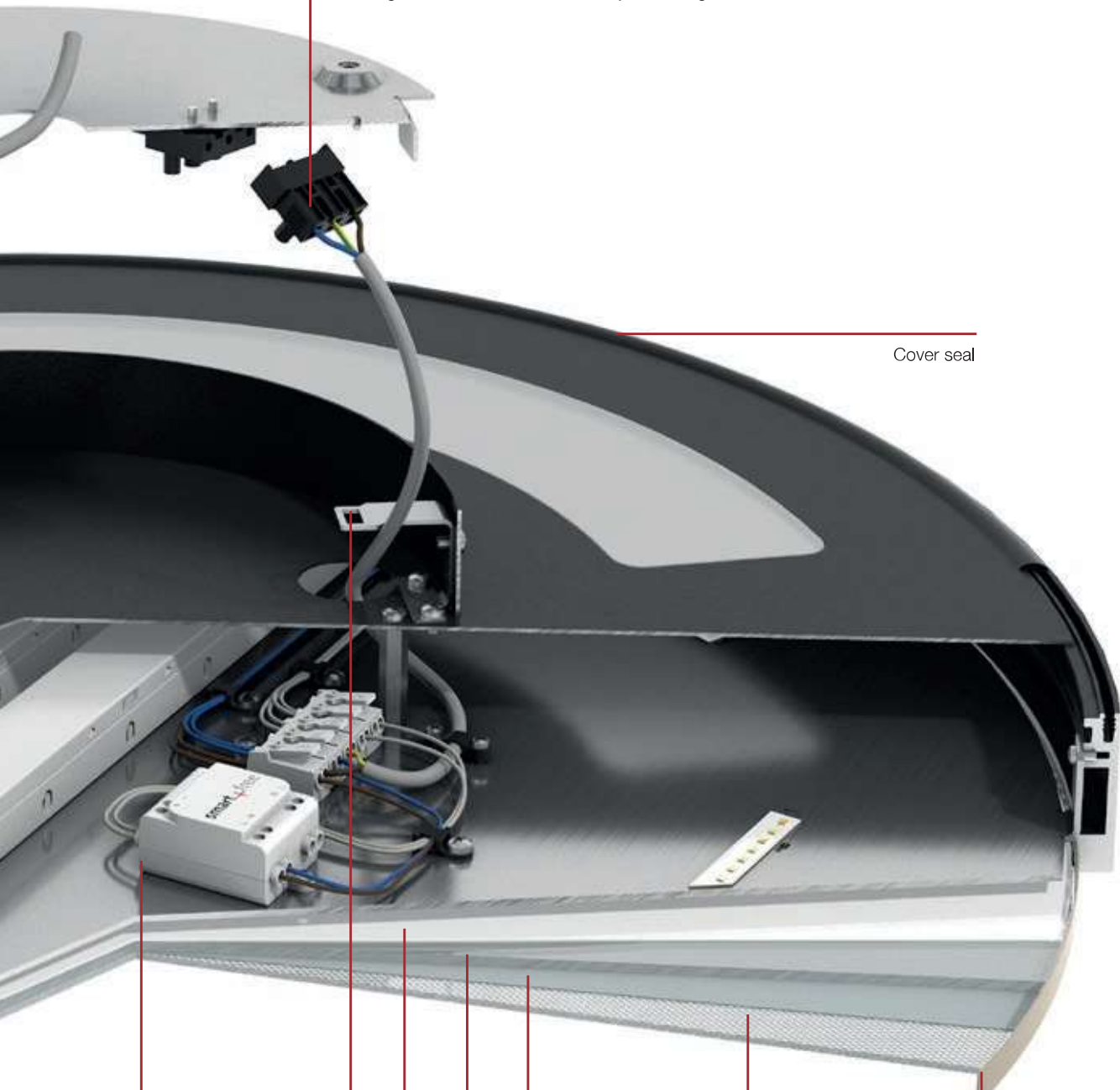

Cover seal

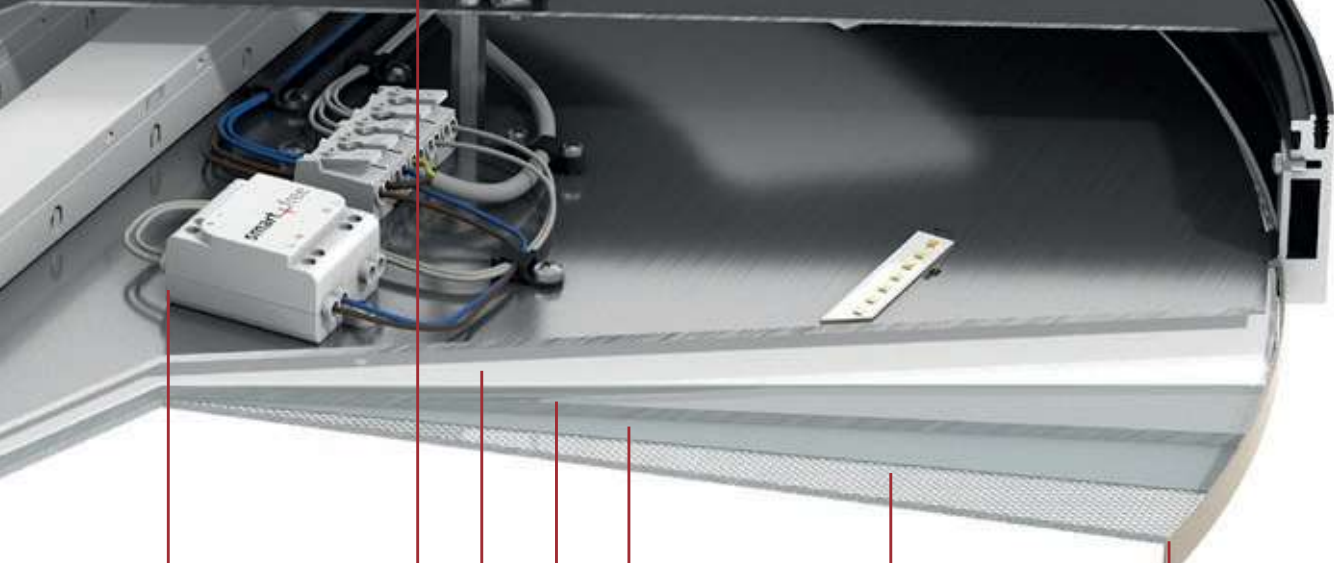

Versions with smart
+ free Bluetooth®
control for wireless
network and operation using Android
/ IOS devices, free
App available for
download



Opal
diffuser foil

Opal or
micro-prismatic diffuser
(optionally with
glass FerroMurano)

Lightguide

Reflector foil



Bracket for
tool-free assembly



LED for direct light emission
(830, 840, tunable white)

RZB SIDELITE® technology:
lateral light injection for
extremely homogeneous
light distribution and
rimless illumination

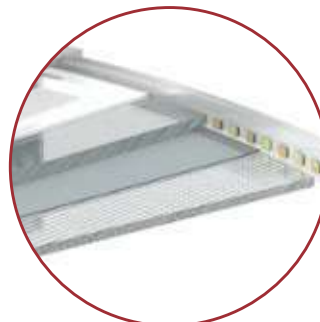

TRIONA®

Technology



Diffuser plastic opal/microprismatic:
ideal for office areas ($UGR \leq 19$) and environments with
computer screens in accordance with EN 12464-1



Versions with smart+free
Bluetooth® control for wireless
network and operation using
Android / iOS devices (on
request), free app available for
download



Tunable white versions, dynamically
adjustable from 2700 K to 6500 K
Ideal for use as part of a
Human Centric Lighting concept

Tool-free mounting system thanks
to the rocker arm mechanism
(patent pending)

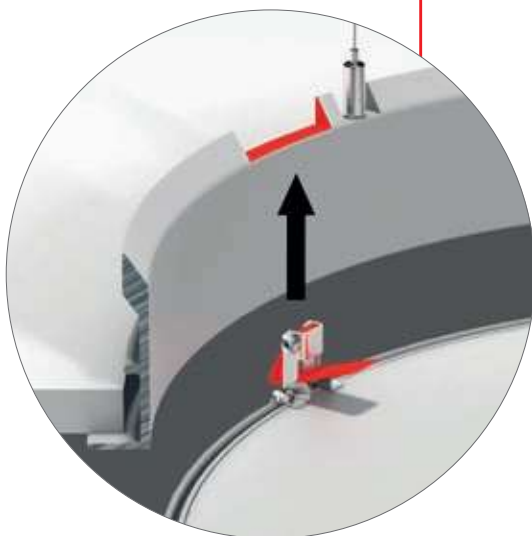

RZB SIDELITE® technology:
lateral light injection for
extremely homogeneous
light distribution and
rimless illumination

Diffuser ① and lightguide ②
made of **non-yellowing PMMA**

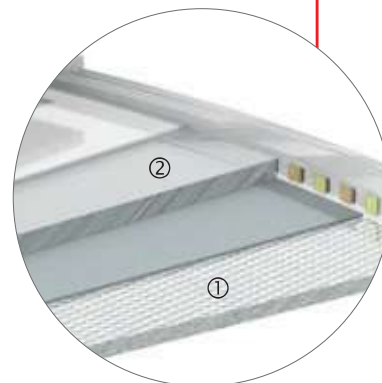



Very easy plug-in installation (Quick connector)

3 different colours are available for the recessed ring and frame made of extruded aluminium profile, powder-coated



3 types of installation

recessed
surface mounted
pendant



3 sizes

Ø 505 mm
Ø 725 mm
Ø 889 mm

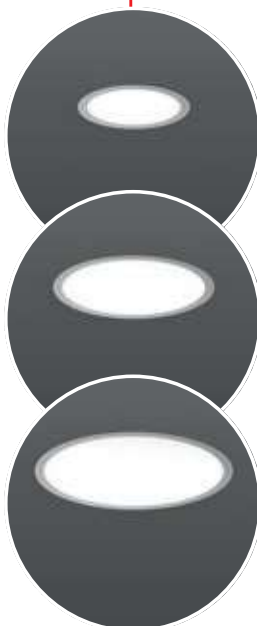

2 diffusers

Plastic (PMMA), opal
Plastic (PMMA) opal/microprismatic
Glass FerroMurano (on request)



TRIONA®

Everything at a glance



4 SIZES

D 461 mm
D 681 mm
D 845 mm
D 1009 mm

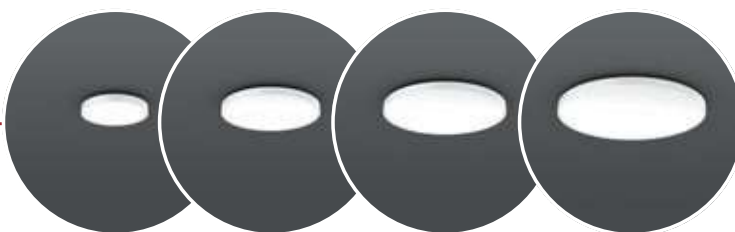

3 COLOURS

white
anthracite metallic
silver metallic



3 DIFFUSERS

Plastic (PMMA) opal,
Plastic (PMMA) microprismatic
Glass FerroMurano (white, red and blue)



3 LIGHT COLOURS

830
840
Tunable White



2 LIGHT EMISSION CHARACTERISTICS

direct
direct/indirect



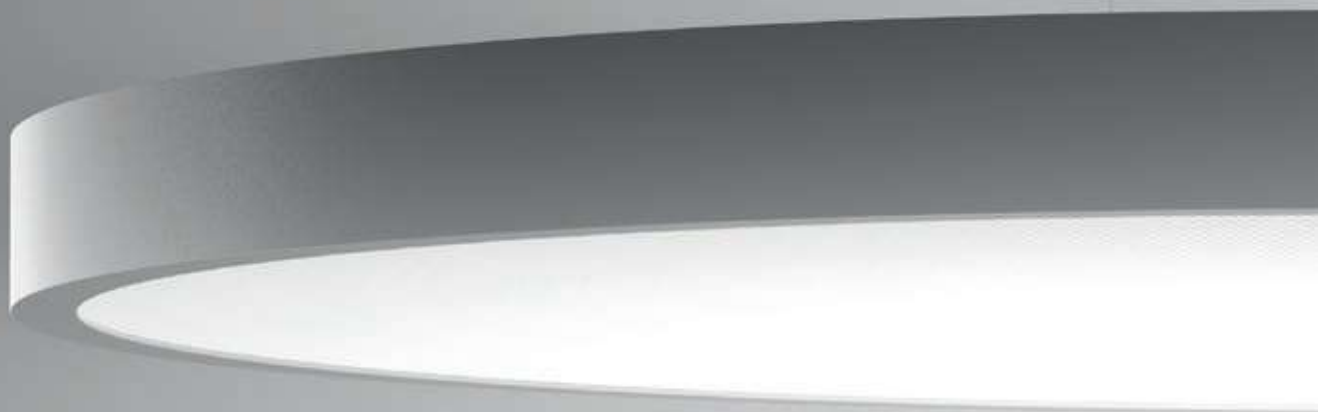

PHOTOMETRICS

- ⊕ RZB SIDELITE® technology: lateral light injection for extremely homogeneous light distribution and rimless illumination
- ⊕ Direct or direct/indirect light emission
- ⊕ Tunable White versions, dynamically adjustable from 2700 K to 6500 K
- ⊕ Colour rendering index Ra > 80
- ⊕ Direct and indirect light emission through diffuser
Lightguide and **diffuser** made of **non-yellowing PMMA**
- ⊕ Ideal for office areas ($UGR \leq 19$) and environments with computer screens in accordance with EN 12464-1
- ⊕ LED rated life 50,000 h (L70, B10)
- ⊕ Colour consistency within 3-steps MacAdam (3 SDCM)
- ⊕ Ideal for use as part of a Human Centric Lighting concept (HCL)

TRIONA®

Product overview | Recessed ceiling luminaires



Comparison LED vs. conventional lamps

- LED 29 / 30 W ≈**
1 x 55 W T16-R (60 W Psys)
- LED 33 / 40 W ≈**
1 x 22 + 40 W T16-R (70 W Psys)
- LED 49 W ≈**
3 x 28 W T16 (92 W Psys)
- LED 70 W ≈**
4 x 28 W T16 (122 W Psys)

Recessed ceiling luminaires | Triona

Type of Protection: IP 20
 Protection Class: I
 Impact Protection: IK03

Cover: sheet steel, powder-coated. Frame: aluminium, powder-coated. Lateral light emission for direct illumination through non-yellowing plastic (PMMA) opal diffuser. Integral driver. Recessed ring: aluminium extrusion profile, powder coated. Suitable for installation in cavity ceilings.

Available colours (X): 2 = white, 31 = anthracite metallic, 4 = silver metallic

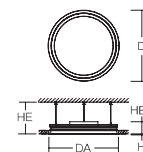

Reference number	Dimensions	Lamp	Light colour	Luminous flux	System power	UGR	dim-able
Recessed ceiling luminaires							
Price Category 21							
Diameter D 505 mm							
312419.00X.12	D 505, H 2, HE 100, HEL 89	LED	830	2700 lm	30 W	22,4	DALI
312419.00X.1.12	D 505, H 2, HE 100, HEL 89	LED	840	2800 lm	30 W	22,5	DALI
Tunable White - 2700 K to 6500 K							
312419.00X.2.12	D 505, H 2, HE 100, HEL 89	LED	827-865	2350 lm	29 W	22,1	DALI
Diameter D 725 mm							
312383.00X.12	D 725, H 2, HE 100, HEL 89	LED	830	3350 lm	33 W	20,2	DALI
312383.00X.1.12	D 725, H 2, HE 100, HEL 89	LED	840	3500 lm	33 W	20,3	DALI
Tunable White - 2700 K to 6500 K							
312383.00X.2.12	D 725, H 2, HE 100, HEL 89	LED	827-865	3200 lm	40 W	20,0	DALI
Diameter D 889 mm							
312387.00X.12	D 889, H 2, HE 100, HEL 89	LED	830	7250 lm	70 W	21,3	DALI
312387.00X.1.12	D 889, H 2, HE 100, HEL 89	LED	840	7500 lm	70 W	21,4	DALI
Tunable White - 2700 K to 6500 K							
312387.00X.2.12	D 889, H 2, HE 100, HEL 89	LED	827-865	4550 lm	49 W	19,6	DALI

Light colour 827 on request.



Diffuser: plastic (PMMA), opal

Recessed ceiling luminaires | Triona

Type of Protection: IP 20
 Protection Class: I
 Impact Protection: IK03

Cover: sheet steel, powder-coated. Frame: aluminium, powder-coated. Lateral light emission for direct illumination through non-yellowing plastic (PMMA) opal/micro-prismatic diffuser (screen-compliant in accordance with EN-12464-1). Integral driver. Recessed ring: aluminium extrusion profile, powder coated. Suitable for installation in cavity ceilings.

Available colours (X): 2 = white, 31 = anthracite metallic, 4 = silver metallic

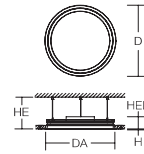

Reference number	Dimensions	Lamp	Light colour	Luminous flux	System power	UGR	dim-able
Recessed ceiling luminaires							
Price Category 21							
Diameter D 505 mm							
312423.00X.12	D 505, H 2, HE 100, HEL 89	LED	830	2950 lm	30 W	20,5	DALI
312423.00X.1.12	D 505, H 2, HE 100, HEL 89	LED	840	3050 lm	30 W	20,6	DALI
Tunable White - 2700 K to 6500 K							
312423.00X.2.12	D 505, H 2, HE 100, HEL 89	LED	827-865	2550 lm	29 W	20,0	DALI
Diameter D 725 mm							
312296.00X.12	D 725, H 2, HE 100, HEL 89	LED	830	3550 lm	33 W	18,5	DALI
312296.00X.1.12	D 725, H 2, HE 100, HEL 89	LED	840	3700 lm	33 W	18,7	DALI
Tunable White - 2700 K to 6500 K							
312296.00X.2.12	D 725, H 2, HE 100, HEL 89	LED	827-865	3400 lm	40 W	17,9	DALI
Diameter D 889 mm							
312299.00X.12	D 889, H 2, HE 100, HEL 89	LED	830	7600 lm	70 W	19,2	DALI
312299.00X.1.12	D 889, H 2, HE 100, HEL 89	LED	840	7900 lm	70 W	19,3	DALI
Tunable White - 2700 K to 6500 K							
312299.00X.2.12	D 889, H 2, HE 100, HEL 89	LED	827-865	4800 lm	49 W	17,8	DALI

Light colour 827 on request.



Comparison LED vs. conventional lamps

LED 29 / 30 W ≈
 1 x 55 W T16-R (60 W Psys)

LED 33 / 40 W ≈
 1 x 22 + 40 W T16-R (70 W Psys)

LED 49 W ≈
 3 x 28 W T16 (92 W Psys)

LED 70 W ≈
 4 x 28 W T16 (122 W Psys)

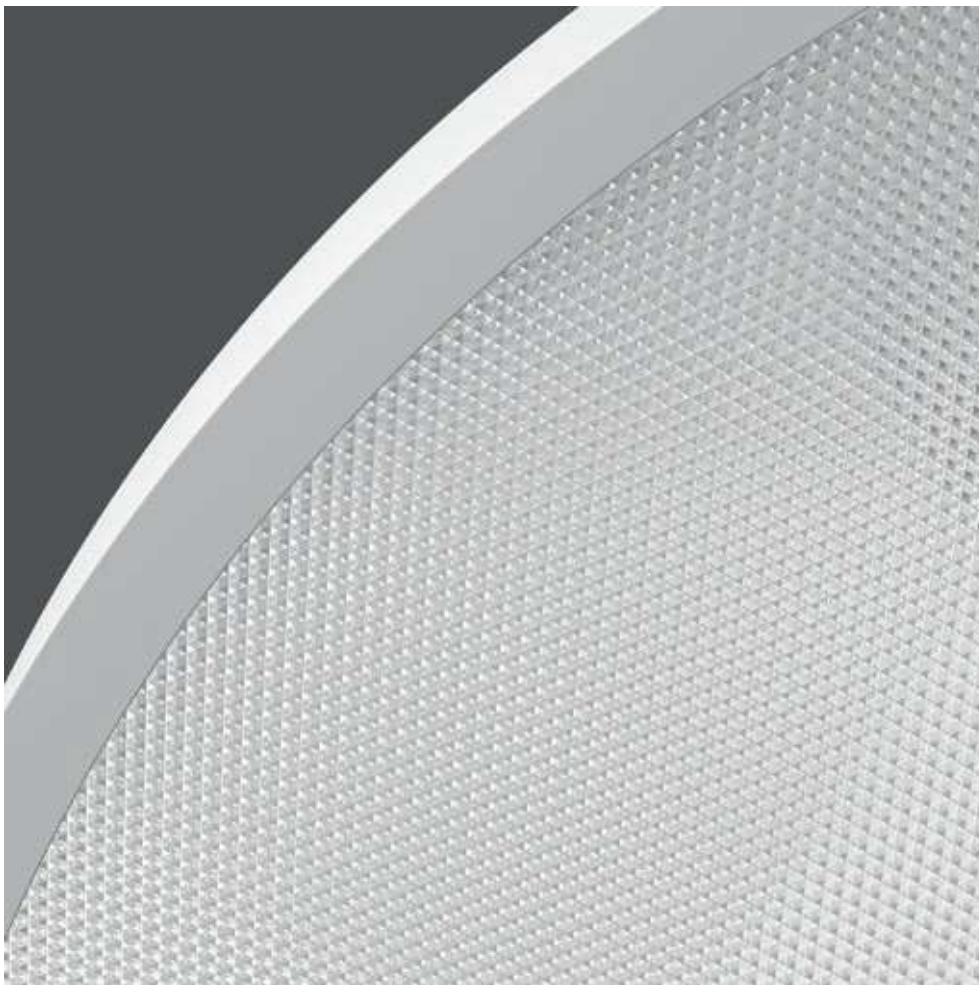

Diffuser: plastic (PMMA) opal/microprismatic

TRIONA®

Product overview | Ceiling and wall luminaires



Ceiling and wall luminaires | Triona

Type of Protection: IP 20
 Protection Class: I
 Impact Protection: IK03

Cover: sheet steel, powder-coated. Frame: aluminium, powder-coated. Lateral light emission for direct illumination through non-yellowing plastic (PMMA) opal diffuser. Indirect light emission through non-yellowing plastic (PMMA) diffuser, satin finish. Integral driver.

Available colours (X): 2 = white, 31 = anthracite metallic, 4 = silver metallic

Versions with smart+free Bluetooth® control for wireless network and operation using Android / iOS devices, free app available for download.

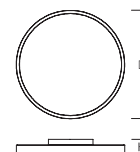

Applies to versions with .76

Comparison LED vs. conventional lamps

- LED 29 / 30 W ≈**
1 x 55 W T16-R (60 W Psys)
- LED 38 / 40 W ≈**
1 x 60 W T16-R (65 W Psys)
- LED 33 / 40 W ≈**
1 x 22 + 40 W T16-R (70 W Psys)
- LED 49 / 61 / 68 W ≈**
3 x 28 W T16 (92 W Psys)
- LED 70 / 76 / 85 W ≈**
4 x 28 W T16 (122 W Psys)
- LED 89 W ≈**
4 x 35 W T16 (150 W Psys)
- LED 110 / 122 W ≈**
4 x 49 W T16 (212 W Psys)



Ceiling and wall luminaires - Direct light emission

Price Category 21

Reference number	Dimensions	Lamp	Light colour	Luminous flux	System power	UGR	dim-able
Diameter D 461 mm							
312419.00X.76	D 461, H 88	LED	830	2700 lm	30 W	22,4	DALI
312419.00X.730	D 461, H 88	LED	830	2700 lm	30 W	22,4	smart+free
312419.00X.1.76	D 461, H 88	LED	840	2800 lm	30 W	22,5	DALI
312419.00X.1.730	D 461, H 88	LED	840	2800 lm	30 W	22,5	smart+free
Tunable White - 2700 K to 6500 K							
312419.00X.2.76	D 461, H 88	LED	827-865	2350 lm	29 W	22,1	DALI
312419.00X.2.730	D 461, H 88	LED	827-865	2350 lm	29 W	22,1	smart+free
Diameter D 681 mm							
312383.00X.76	D 681, H 88	LED	830	3350 lm	33 W	20,2	DALI
312383.00X.730	D 681, H 88	LED	830	3350 lm	33 W	20,2	smart+free
312383.00X.1.76	D 681, H 88	LED	840	3500 lm	33 W	20,3	DALI
312383.00X.1.730	D 681, H 88	LED	840	3500 lm	33 W	20,3	smart+free
Tunable White - 2700 K to 6500 K							
312383.00X.2.76	D 681, H 88	LED	827-865	3200 lm	40 W	20,0	DALI
312383.00X.2.730	D 681, H 88	LED	827-865	3200 lm	40 W	20,0	smart+free
Diameter D 845 mm							
312387.00X.76	D 845, H 88	LED	830	7250 lm	70 W	21,3	DALI
312387.00X.730	D 845, H 88	LED	830	7250 lm	70 W	21,3	smart+free
312387.00X.1.76	D 845, H 88	LED	840	7500 lm	70 W	21,4	DALI
312387.00X.1.730	D 845, H 88	LED	840	7500 lm	70 W	21,4	smart+free
Tunable White - 2700 K to 6500 K							
312387.00X.2.76	D 845, H 88	LED	827-865	4550 lm	49 W	19,6	DALI
312387.00X.2.730	D 845, H 88	LED	827-865	4550 lm	49 W	19,6	smart+free
Diameter D 1009 mm							
312391.00X.76	D 1009, H 88	LED	830	8400 lm	89 W	20,5	DALI
312391.00X.730	D 1009, H 88	LED	830	8400 lm	89 W	20,5	smart+free
312391.00X.1.76	D 1009, H 88	LED	840	8700 lm	89 W	20,6	DALI
312391.00X.1.730	D 1009, H 88	LED	840	8700 lm	89 W	20,6	smart+free
Tunable White - 2700 K to 6500 K							
312391.00X.2.76	D 1009, H 88	LED	827-865	5450 lm	61 W	19,0	DALI
312391.00X.2.730	D 1009, H 88	LED	827-865	5450 lm	61 W	19,0	smart+free

Light colour 827 on request.

Reference number	Dimensions	Lamp	Light colour	Luminous flux	System power	UGR	dim-able
Ceiling and wall luminaires - Direct 70% - indirect 30% light emission							
Price Category 21							
Diameter D 461 mm							
312420.00X.76	D 461, H 88	LED	830	3350 lm	40 W	21,1	DALI
312420.00X.730	D 461, H 88	LED	830	3350 lm	40 W	21,1	smart+free
312420.00X.1.76	D 461, H 88	LED	840	3500 lm	40 W	21,3	DALI
312420.00X.1.730	D 461, H 88	LED	840	3500 lm	40 W	21,3	smart+free
Tunable White - 2700 K to 6500 K							
312420.00X.2.76	D 461, H 88	LED	827-865	2900 lm	38 W	20,8	DALI
312420.00X.2.730	D 461, H 88	LED	827-865	2900 lm	38 W	20,8	smart+free
Diameter D 681 mm							
312384.00X.76	D 681, H 88	LED	830	6000 lm	68 W	19,1	DALI
312384.00X.730	D 681, H 88	LED	830	6000 lm	68 W	19,1	smart+free
312384.00X.1.76	D 681, H 88	LED	840	6250 lm	68 W	19,2	DALI
312384.00X.1.730	D 681, H 88	LED	840	6250 lm	68 W	19,2	smart+free
Tunable White - 2700 K to 6500 K							
312384.00X.2.76	D 681, H 88	LED	827-865	4400 lm	61 W	18,0	DALI
312384.00X.2.730	D 681, H 88	LED	827-865	4400 lm	61 W	18,0	smart+free
Diameter D 845 mm							
312388.00X.76	D 845, H 88	LED	830	9500 lm	110 W	19,1	DALI
312388.00X.730	D 845, H 88	LED	830	9500 lm	110 W	19,1	smart+free
312388.00X.1.76	D 845, H 88	LED	840	9900 lm	110 W	19,2	DALI
312388.00X.1.730	D 845, H 88	LED	840	9900 lm	110 W	19,2	smart+free
Tunable White - 2700 K to 6500 K							
312388.00X.2.76	D 845, H 88	LED	827-865	6550 lm	76 W	17,8	DALI
312388.00X.2.730	D 845, H 88	LED	827-865	6550 lm	76 W	17,8	smart+free
Diameter D 1009 mm							
312392.00X.76	D 1009, H 88	LED	830	11300 lm	122 W	18,4	DALI
312392.00X.730	D 1009, H 88	LED	830	11300 lm	122 W	18,4	smart+free
312392.00X.1.76	D 1009, H 88	LED	840	11800 lm	122 W	18,6	DALI
312392.00X.1.730	D 1009, H 88	LED	840	11800 lm	122 W	18,6	smart+free
Tunable White - 2700 K to 6500 K							
312392.00X.2.76	D 1009, H 88	LED	827-865	7050 lm	85 W	16,8	DALI
312392.00X.2.730	D 1009, H 88	LED	827-865	7050 lm	85 W	16,8	smart+free

Light colour 827 on request.



Diffuser: plastic (PMMA), opal

TRIONA®

Product overview | Ceiling and wall luminaires



Ceiling and wall luminaires | Triona

Type of Protection: IP 20
 Protection Class: I
 Impact Protection: IK03

Cover: sheet steel, powder-coated. Frame: aluminium, powder-coated. Lateral light emission for direct illumination through non-yellowing plastic (PMMA) opal/micro-prismatic diffuser (screen-compliant in accordance with EN-12464-1). Indirect light emission through non-yellowing plastic (PMMA) diffuser, satin finish. Integral driver.

Available colours (X): 2 = white, 31 = anthracite metallic, 4 = silver metallic

Versions with smart+free Bluetooth® control for wireless network and operation using Android / iOS devices, free app available for download.

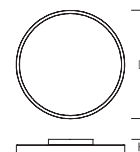

Applies to versions with .76

Comparison LED vs. conventional lamps

- LED 29 / 30 W ≈**
1 x 55 W T16-R (60 W Psys)
- LED 38 / 40 W ≈**
1 x 60 W T16-R (65 W Psys)
- LED 33 / 40 W ≈**
1 x 22 + 40 W T16-R (70 W Psys)
- LED 49 / 61 / 68 W ≈**
3 x 28 W T16 (92 W Psys)
- LED 70 / 76 / 85 W ≈**
4 x 28 W T16 (122 W Psys)
- LED 89 W ≈**
4 x 35 W T16 (150 W Psys)
- LED 110 / 122 W ≈**
4 x 49 W T16 (212 W Psys)



Ceiling and wall luminaires - Direct light emission

Price Category 21

Reference number	Dimensions	Lamp	Light colour	Luminous flux	System power	UGR	dim-able
Diameter D 461 mm							
312423.00X.76	D 461, H 88	LED	830	2950 lm	30 W	20,5	DALI
312423.00X.730	D 461, H 88	LED	830	2950 lm	30 W	20,5	smart+free
312423.00X.1.76	D 461, H 88	LED	840	3050 lm	30 W	20,6	DALI
312423.00X.1.730	D 461, H 88	LED	840	3050 lm	30 W	20,6	smart+free
Tunable White - 2700 K to 6500 K							
312423.00X.2.76	D 461, H 88	LED	827-865	2550 lm	29 W	20,0	DALI
312423.00X.2.730	D 461, H 88	LED	827-865	2550 lm	29 W	20,0	smart+free
Diameter D 681 mm							
312296.00X.76	D 681, H 88	LED	830	3550 lm	33 W	18,5	DALI
312296.00X.730	D 681, H 88	LED	830	3550 lm	33 W	18,5	smart+free
312296.00X.1.76	D 681, H 88	LED	840	3700 lm	33 W	18,6	DALI
312296.00X.1.730	D 681, H 88	LED	840	3700 lm	33 W	18,6	smart+free
Tunable White - 2700 K to 6500 K							
312296.00X.2.76	D 681, H 88	LED	827-865	3400 lm	40 W	17,9	DALI
312296.00X.2.730	D 681, H 88	LED	827-865	3400 lm	40 W	17,9	smart+free
Diameter D 845 mm							
312299.00X.76	D 845, H 88	LED	830	7600 lm	70 W	19,2	DALI
312299.00X.730	D 845, H 88	LED	830	7600 lm	70 W	19,2	smart+free
312299.00X.1.76	D 845, H 88	LED	840	7900 lm	70 W	19,3	DALI
312299.00X.1.730	D 845, H 88	LED	840	7900 lm	70 W	19,3	smart+free
Tunable White - 2700 K to 6500 K							
312299.00X.2.76	D 845, H 88	LED	827-865	4800 lm	49 W	17,8	DALI
312299.00X.2.730	D 845, H 88	LED	827-865	4800 lm	49 W	17,8	smart+free
Diameter D 1009 mm							
312302.00X.76	D 1009, H 88	LED	830	8850 lm	89 W	18,7	DALI
312302.00X.730	D 1009, H 88	LED	830	8850 lm	89 W	18,7	smart+free
312302.00X.1.76	D 1009, H 88	LED	840	9200 lm	89 W	18,8	DALI
312302.00X.1.730	D 1009, H 88	LED	840	9200 lm	89 W	18,8	smart+free
Tunable White - 2700 K to 6500 K							
312302.00X.2.76	D 1009, H 88	LED	827-865	5700 lm	61 W	16,7	DALI
312302.00X.2.730	D 1009, H 88	LED	827-865	5700 lm	61 W	16,7	smart+free

Light colour 827 on request.

Reference number	Dimensions	Lamp	Light colour	Luminous flux	System power	UGR	dim-able
------------------	------------	------	--------------	---------------	--------------	-----	----------

Ceiling and wall luminaires - Direct 70% - indirect 30% light emission							Price Category 21
Diameter D 461 mm							
312424.00X.76	D 461, H 88	LED	830	3500 lm	40 W	19,2	DALI
312424.00X.730	D 461, H 88	LED	830	3500 lm	40 W	19,2	smart+free
312424.00X.1.76	D 461, H 88	LED	840	3650 lm	40 W	19,3	DALI
312424.00X.1.730	D 461, H 88	LED	840	3650 lm	40 W	19,3	smart+free
Tunable White - 2700 K to 6500 K							
312424.00X.2.76	D 461, H 88	LED	827-865	3100 lm	38 W	18,8	DALI
312424.00X.2.730	D 461, H 88	LED	827-865	3100 lm	38 W	18,8	smart+free
Diameter D 681 mm							
312297.00X.76	D 681, H 88	LED	830	6300 lm	68 W	17,4	DALI
312297.00X.730	D 681, H 88	LED	830	6300 lm	68 W	17,4	smart+free
312297.00X.1.76	D 681, H 88	LED	840	6550 lm	68 W	17,5	DALI
312297.00X.1.730	D 681, H 88	LED	840	6550 lm	68 W	17,5	smart+free
Tunable White - 2700 K to 6500 K							
312297.00X.2.76	D 681, H 88	LED	827-865	4650 lm	61 W	16,0	DALI
312297.00X.2.730	D 681, H 88	LED	827-865	4650 lm	61 W	16,0	smart+free
Diameter D 845 mm							
312300.00X.76	D 845, H 88	LED	830	10000 lm	110 W	16,9	DALI
312300.00X.730	D 845, H 88	LED	830	10000 lm	110 W	16,9	smart+free
312300.00X.1.76	D 845, H 88	LED	840	10400 lm	110 W	17,0	DALI
312300.00X.1.730	D 845, H 88	LED	840	10400 lm	110 W	17,0	smart+free
Tunable White - 2700 K to 6500 K							
312300.00X.2.76	D 845, H 88	LED	827-865	6900 lm	76 W	15,8	DALI
312300.00X.2.730	D 845, H 88	LED	827-865	6900 lm	76 W	15,8	smart+free
Diameter D 1009 mm							
312303.00X.76	D 1009, H 88	LED	830	11900 lm	122 W	16,9	DALI
312303.00X.730	D 1009, H 88	LED	830	11900 lm	122 W	16,9	smart+free
312303.00X.1.76	D 1009, H 88	LED	840	12400 lm	122 W	17,1	DALI
312303.00X.1.730	D 1009, H 88	LED	840	12400 lm	122 W	17,1	smart+free
Tunable White - 2700 K to 6500 K							
312303.00X.2.76	D 1009, H 88	LED	827-865	7450 lm	85 W	15,1	DALI
312303.00X.2.730	D 1009, H 88	LED	827-865	7450 lm	85 W	15,1	smart+free

Light colour 827 on request.

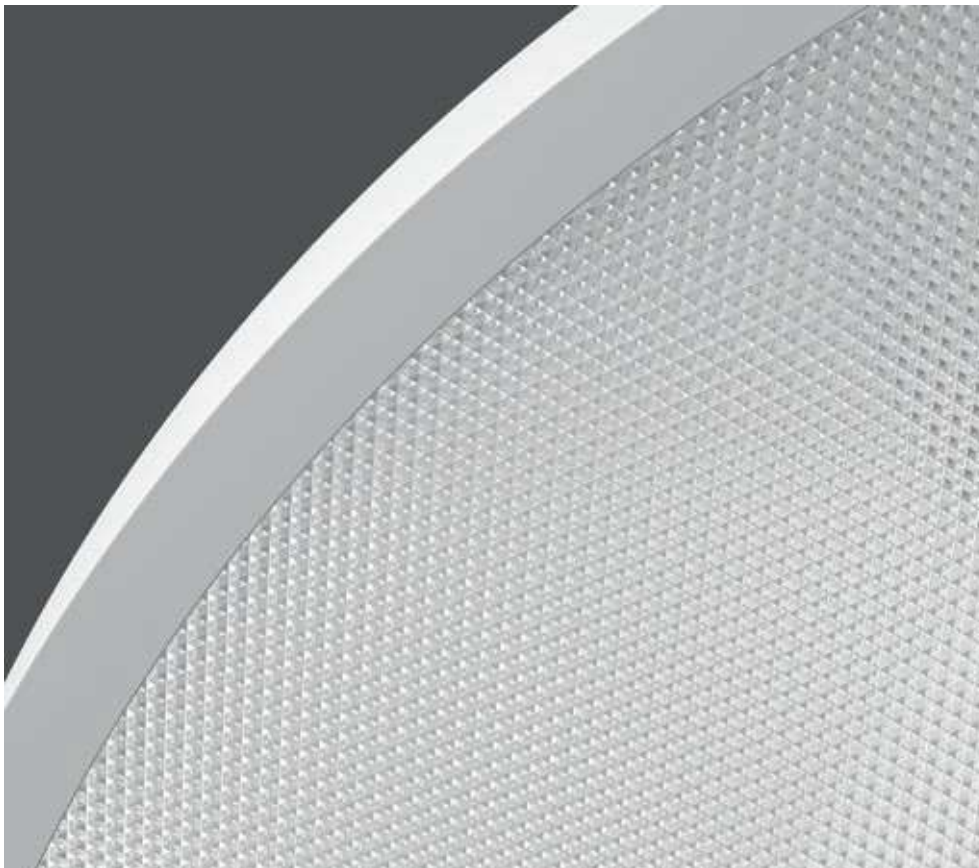

Diffuser plastic (PMMA)
opal/microprismatic

TRIONA®

Product overview | Ceiling and wall luminaires



Applies to versions with .76
Touch DIM Sensor

Ceiling and wall luminaires | Triona FerroMurano

Type of Protection: IP 20
Protection Class: I
Impact Protection: IK03

Cover: sheet steel, powder-coated. Frame: aluminium, powder-coated. Lateral light emission for direct illumination through handmade FerroMurano coloured glass. Indirect light emission through non-yellowing plastic (PMMA) diffuser, satin finish. Integral driver.

Available colours (X): 2 = white, 31 = anthracite metallic, 4 = silver metallic

Versions with smart+free Bluetooth® control for wireless network and operation using Android / iOS devices, free app available for download.

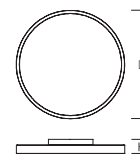

Reference number	Dimensions	Lamp	Light colour	Luminous flux	System power	dim-able
------------------	------------	------	--------------	---------------	--------------	----------

Ceiling and wall luminaires - Direct 70% - indirect 30% light emission

Price Category 21



Glass FerroMurano red

Diameter D 461 mm

312411.00X.76	D 461, H 88	LED	830	2450 lm	40 W	DALI
312411.00X.730	D 461, H 88	LED	830	2450 lm	40 W	smart+free
312411.00X.1.76	D 461, H 88	LED	840	2550 lm	40 W	DALI
312411.00X.1.730	D 461, H 88	LED	840	2550 lm	40 W	smart+free

Diameter D 681 mm

312291.00X.76	D 681, H 88	LED	830	4300 lm	68 W	DALI
312291.00X.730	D 681, H 88	LED	830	4300 lm	68 W	smart+free
312291.00X.1.76	D 681, H 88	LED	840	4450 lm	68 W	DALI
312291.00X.1.730	D 681, H 88	LED	840	4450 lm	68 W	smart+free

Glass FerroMurano blue

Diameter D 461 mm

312412.00X.76	D 461, H 88	LED	830	2800 lm	40 W	DALI
312412.00X.730	D 461, H 88	LED	830	2800 lm	40 W	smart+free
312412.00X.1.76	D 461, H 88	LED	840	2950 lm	40 W	DALI
312412.00X.1.730	D 461, H 88	LED	840	2950 lm	40 W	smart+free

Diameter D 681 mm

312292.00X.76	D 681, H 88	LED	830	5150 lm	68 W	DALI
312292.00X.730	D 681, H 88	LED	830	5150 lm	68 W	smart+free
312292.00X.1.76	D 681, H 88	LED	840	5350 lm	68 W	DALI
312292.00X.1.730	D 681, H 88	LED	840	5350 lm	68 W	smart+free

Glass FerroMurano white

Diameter D 461 mm

312410.00X.76	D 461, H 88	LED	830	3150 lm	40 W	DALI
312410.00X.730	D 461, H 88	LED	830	3150 lm	40 W	smart+free
312410.00X.1.76	D 461, H 88	LED	840	3300 lm	40 W	DALI
312410.00X.1.730	D 461, H 88	LED	840	3300 lm	40 W	smart+free

Diameter D 681 mm

312290.00X.76	D 681, H 88	LED	830	5800 lm	68 W	DALI
312290.00X.730	D 681, H 88	LED	830	5800 lm	68 W	smart+free
312290.00X.1.76	D 681, H 88	LED	840	6000 lm	68 W	DALI
312290.00X.1.730	D 681, H 88	LED	840	6000 lm	68 W	smart+free

The luminaire flux and UGR of each luminaire varies due to the difference in colour intensity and structure of the glasses. Light colour 827 on request.

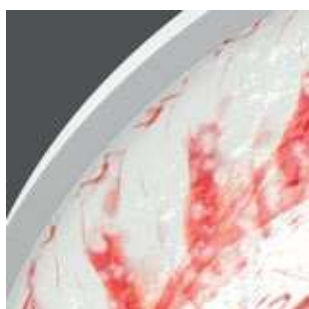

Glass FerroMurano red

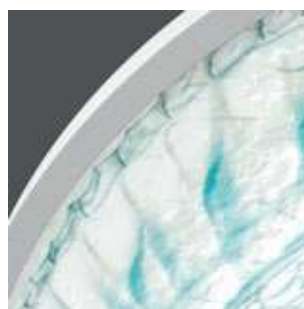

Glass FerroMurano blue



Glass FerroMurano white



TRIONA®

Product overview | Pendant luminaires



Pendant luminaires | Triona

Type of Protection: IP 20
 Protection Class: I
 Impact Protection: IK03
 Suspension Length: 500-1200 mm

Cover: sheet steel, powder-coated. Frame: aluminium, powder-coated. Lateral light emission for direct illumination through non-yellowing plastic (PMMA) opal diffuser. Indirect light emission through non-yellowing plastic (PMMA) diffuser, satin finish. Canopy: aluminium, powder-coated, 3-point steel cable suspension, steplessly adjustable. Special lengths available on request. Integral driver.

Available colours (X): 2 = white, 31 = anthracite metallic, 4 = silver metallic

Versions with smart+free Bluetooth® control for wireless network and operation using Android / iOS devices, free app available for download.

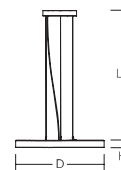

Comparison LED vs. conventional lamps

- LED 29 W** ≈
1 x 55 W T16-R (60 W Psys)
- LED 30 W** ≈
1 x 60 W T16-R (65 W Psys)
- LED 33 / 40 W** ≈
1 x 22 + 40 W T16-R (70 W Psys)
- LED 49 / 61 W** ≈
3 x 28 W T16 (92 W Psys)
- LED 70 W** ≈
4 x 28 W T16 (122 W Psys)
- LED 89 W** ≈
4 x 35 W T16 (150 W Psys)

Reference number	Dimensions	Lamp	Light colour	Luminous flux	System power	UGR	dim-able
Pendant luminaires - Direct light emission							
Price Category 21							
Diameter D 461 mm, Canopy Ø 263 mm, h 40 mm							
312421.00X.76	D 461, H 52	LED	830	2700 lm	30 W	22,4	DALI
312421.00X.730	D 461, H 52	LED	830	2700 lm	30 W	22,4	smart+free
312421.00X.1.76	D 461, H 52	LED	840	2800 lm	30 W	22,5	DALI
312421.00X.1.730	D 461, H 52	LED	840	2800 lm	30 W	22,5	smart+free
Tunable White - 2700 K to 6500 K							
312421.00X.2.76	D 461, H 52	LED	827-865	2350 lm	29 W	22,1	DALI
312421.00X.2.730	D 461, H 52	LED	827-865	2350 lm	29 W	22,1	smart+free
Diameter D 681 mm, Canopy Ø 263 mm, h 40 mm							
312385.00X.76	D 681, H 52	LED	830	3350 lm	33 W	20,2	DALI
312385.00X.730	D 681, H 52	LED	830	3350 lm	33 W	20,2	smart+free
312385.00X.1.76	D 681, H 52	LED	840	3500 lm	33 W	20,3	DALI
312385.00X.1.730	D 681, H 52	LED	840	3500 lm	33 W	20,3	smart+free
Tunable White - 2700 K to 6500 K							
312385.00X.2.76	D 681, H 52	LED	827-865	3200 lm	40 W	20,0	DALI
312385.00X.2.730	D 681, H 52	LED	827-865	3200 lm	40 W	20,0	smart+free
Diameter D 845 mm, Canopy Ø 263 mm, h 40 mm							
312389.00X.76	D 845, H 52	LED	830	7250 lm	70 W	21,3	DALI
312389.00X.730	D 845, H 52	LED	830	7250 lm	70 W	21,3	smart+free
312389.00X.1.76	D 845, H 52	LED	840	7500 lm	70 W	21,4	DALI
312389.00X.1.730	D 845, H 52	LED	840	7500 lm	70 W	21,4	smart+free
Tunable White - 2700 K to 6500 K							
312389.00X.2.76	D 845, H 52	LED	827-865	4550 lm	49 W	19,6	DALI
312389.00X.2.730	D 845, H 52	LED	827-865	4550 lm	49 W	19,6	smart+free
Diameter D 1009 mm, Canopy Ø 263 mm, h 40 mm							
312393.00X.76	D 1009, H 52	LED	830	8400 lm	89 W	20,5	DALI
312393.00X.730	D 1009, H 52	LED	830	8400 lm	89 W	20,5	smart+free
312393.00X.1.76	D 1009, H 52	LED	840	8700 lm	89 W	20,6	DALI
312393.00X.1.730	D 1009, H 52	LED	840	8700 lm	89 W	20,6	smart+free
Tunable White - 2700 K to 6500 K							
312393.00X.2.76	D 1009, H 52	LED	827-865	5450 lm	61 W	19,0	DALI
312393.00X.2.730	D 1009, H 52	LED	827-865	5450 lm	61 W	19,0	smart+free

Light colour 827 on request.

Reference number	Dimensions	Lamp	Light colour	Luminous flux	System power	UGR	dim-able
------------------	------------	------	--------------	---------------	--------------	-----	----------



Pendant luminaires - Direct 70% - indirect 30% light emission

Price Category 21

Diameter D 461 mm, Canopy Ø 263 mm, h 40 mm

312422.00X.76	D 461, H 52	LED	830	3350 lm	40 W	21,1	DALI
312422.00X.730	D 461, H 52	LED	830	3350 lm	40 W	21,1	smart+free
312422.00X.1.76	D 461, H 52	LED	840	3500 lm	40 W	21,3	DALI
312422.00X.1.730	D 461, H 52	LED	840	3500 lm	40 W	21,3	smart+free

Tunable White - 2700 K to 6500 K

312422.00X.2.76	D 461, H 52	LED	827-865	2900 lm	38 W	20,8	DALI
312422.00X.2.730	D 461, H 52	LED	827-865	2900 lm	38 W	20,8	smart+free

Diameter D 681 mm, Canopy Ø 263 mm, h 40 mm

312386.00X.76	D 681, H 52	LED	830	6000 lm	68 W	19,1	DALI
312386.00X.730	D 681, H 52	LED	830	6000 lm	68 W	19,1	smart+free
312386.00X.1.76	D 681, H 52	LED	840	6250 lm	68 W	19,2	DALI
312386.00X.1.730	D 681, H 52	LED	840	6250 lm	68 W	19,2	smart+free

Tunable White - 2700 K to 6500 K

312386.00X.2.76	D 681, H 52	LED	827-865	4400 lm	61 W	18,0	DALI
312386.00X.2.730	D 681, H 52	LED	827-865	4400 lm	61 W	18,0	smart+free

Diameter D 845 mm, Canopy Ø 263 mm, h 40 mm

312390.00X.76	D 845, H 52	LED	830	9500 lm	110 W	19,1	DALI
312390.00X.730	D 845, H 52	LED	830	9500 lm	110 W	19,1	smart+free
312390.00X.1.76	D 845, H 52	LED	840	9900 lm	110 W	19,2	DALI
312390.00X.1.730	D 845, H 52	LED	840	9900 lm	110 W	19,2	smart+free

Tunable White - 2700 K to 6500 K

312390.00X.2.76	D 845, H 52	LED	827-865	6550 lm	76 W	17,8	DALI
312390.00X.2.730	D 845, H 52	LED	827-865	6550 lm	76 W	17,8	smart+free

Diameter D 1009 mm, Canopy Ø 263 mm, h 40 mm

312394.00X.76	D 1009, H 52	LED	830	11300 lm	122 W	18,4	DALI
312394.00X.730	D 1009, H 52	LED	830	11300 lm	122 W	18,4	smart+free
312394.00X.1.76	D 1009, H 52	LED	840	11800 lm	122 W	18,6	DALI
312394.00X.1.730	D 1009, H 52	LED	840	11800 lm	122 W	18,6	smart+free

Tunable White - 2700 K to 6500 K

312394.00X.2.76	D 1009, H 52	LED	827-865	7050 lm	85 W	16,8	DALI
312394.00X.2.730	D 1009, H 52	LED	827-865	7050 lm	85 W	16,8	smart+free

Light colour 827 on request.



Diffuser: plastic (PMMA), opal

TRIONA®

Product overview | Pendant luminaires



Pendant luminaires | Triona

Type of Protection: IP 20
 Protection Class: I
 Impact Protection: IK03
 Suspension Length: 500-1200 mm

Cover: sheet steel, powder-coated. Frame: aluminium, powder-coated. Lateral light emission for direct illumination through non-yellowing plastic (PMMA) opal/micro-prismatic diffuser (screen-compliant in accordance with EN-12464-1). Indirect light emission through non-yellowing plastic (PMMA) diffuser, satin finish. Canopy: aluminium, powder-coated. 3-point steel cable suspension, steplessly adjustable. Special lengths available on request. Integral driver.

Available colours (X): 2 = white, 31 = anthracite metallic, 4 = silver metallic

Versions with smart+free Bluetooth® control for wireless network and operation using Android / iOS devices, free app available for download.

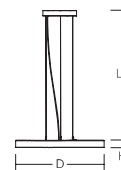

Comparison LED vs. conventional lamps

- LED 29 W** ≈
1 x 55 W T16-R (60 W Psys)
- LED 30 W** ≈
1 x 60 W T16-R (65 W Psys)
- LED 33 / 40 W** ≈
1 x 22 + 40 W T16-R (70 W Psys)
- LED 49 / 61 W** ≈
3 x 28 W T16 (92 W Psys)
- LED 70 W** ≈
4 x 28 W T16 (122 W Psys)
- LED 89 W** ≈
4 x 35 W T16 (150 W Psys)

Reference number	Dimensions	Lamp	Light colour	Luminous flux	System power	UGR	dim-able
Pendant luminaires - Direct light emission							
Price Category 21							
Diameter D 461 mm, Canopy Ø 263 mm, h 40 mm							
312425.00X.76	D 461, H 52	LED	830	2950 lm	30 W	20,5	DALI
312425.00X.730	D 461, H 52	LED	830	2950 lm	30 W	20,5	smart+free
312425.00X.1.76	D 461, H 52	LED	840	3050 lm	30 W	20,6	DALI
312425.00X.1.730	D 461, H 52	LED	840	3050 lm	30 W	20,6	smart+free
Tunable White - 2700 K to 6500 K							
312425.00X.2.76	D 461, H 52	LED	827-865	2550 lm	29 W	20,0	DALI
312425.00X.2.730	D 461, H 52	LED	827-865	2550 lm	29 W	20,0	smart+free
Diameter D 681 mm, Canopy Ø 263 mm, h 40 mm							
312360.00X.76	D 681, H 52	LED	830	3550 lm	33 W	18,5	DALI
312360.00X.730	D 681, H 52	LED	830	3550 lm	33 W	18,5	smart+free
312360.00X.1.76	D 681, H 52	LED	840	3700 lm	33 W	18,6	DALI
312360.00X.1.730	D 681, H 52	LED	840	3700 lm	33 W	18,6	smart+free
Tunable White - 2700 K to 6500 K							
312360.00X.2.76	D 681, H 52	LED	827-865	3400 lm	40 W	17,9	DALI
312360.00X.2.730	D 681, H 52	LED	827-865	3400 lm	40 W	17,9	smart+free
Diameter D 845 mm, Canopy Ø 263 mm, h 40 mm							
312361.00X.76	D 845, H 52	LED	830	7600 lm	70 W	19,2	DALI
312361.00X.730	D 845, H 52	LED	830	7600 lm	70 W	19,2	smart+free
312361.00X.1.76	D 845, H 52	LED	840	7900 lm	70 W	19,3	DALI
312361.00X.1.730	D 845, H 52	LED	840	7900 lm	70 W	19,3	smart+free
Tunable White - 2700 K to 6500 K							
312361.00X.2.76	D 845, H 52	LED	827-865	4800 lm	49 W	17,8	DALI
312361.00X.2.730	D 845, H 52	LED	827-865	4800 lm	49 W	17,8	smart+free
Diameter D 1009 mm, Canopy Ø 263 mm, h 40 mm							
312362.00X.76	D 1009, H 52	LED	830	8850 lm	89 W	18,7	DALI
312362.00X.730	D 1009, H 52	LED	830	8850 lm	89 W	18,7	smart+free
312362.00X.1.76	D 1009, H 52	LED	840	9200 lm	89 W	18,8	DALI
312362.00X.1.730	D 1009, H 52	LED	840	9200 lm	89 W	18,8	smart+free
Tunable White - 2700 K to 6500 K							
312362.00X.2.76	D 1009, H 52	LED	827-865	5700 lm	61 W	16,7	DALI
312362.00X.2.730	D 1009, H 52	LED	827-865	5700 lm	61 W	16,7	smart+free

Light colour 827 on request.

Reference number	Dimensions	Lamp	Light colour	Luminous flux	System power	UGR	dim-able
Pendant luminaires - Direct 70% - indirect 30% light emission							
Diameter D 461 mm, Canopy Ø 263 mm, h 40 mm							
312426.00X.76	D 461, H 52	LED	830	3500 lm	40 W	19,2	DALI
312426.00X.730	D 461, H 52	LED	830	3500 lm	40 W	19,2	smart+free
312426.00X.1.76	D 461, H 52	LED	840	3650 lm	40 W	19,3	DALI
312426.00X.1.730	D 461, H 52	LED	840	3650 lm	40 W	19,3	smart+free
Tunable White - 2700 K to 6500 K							
312426.00X.2.76	D 461, H 52	LED	827-865	3100 lm	38 W	18,8	DALI
312426.00X.2.730	D 461, H 52	LED	827-865	3100 lm	38 W	18,8	smart+free
Diameter D 681 mm, Canopy Ø 263 mm, h 40 mm							
312298.00X.76	D 681, H 52	LED	830	6300 lm	68 W	17,4	DALI
312298.00X.730	D 681, H 52	LED	830	6300 lm	68 W	17,4	smart+free
312298.00X.1.76	D 681, H 52	LED	840	6550 lm	68 W	17,5	DALI
312298.00X.1.730	D 681, H 52	LED	840	6550 lm	68 W	17,5	smart+free
Tunable White - 2700 K to 6500 K							
312298.00X.2.76	D 681, H 52	LED	827-865	4650 lm	61 W	16,0	DALI
312298.00X.2.730	D 681, H 52	LED	827-865	4650 lm	61 W	16,0	smart+free
Diameter D 845 mm, Canopy Ø 263 mm, h 40 mm							
312301.00X.76	D 845, H 52	LED	830	10000 lm	110 W	16,9	DALI
312301.00X.730	D 845, H 52	LED	830	10000 lm	110 W	16,9	smart+free
312301.00X.1.76	D 845, H 52	LED	840	10400 lm	110 W	17,0	DALI
312301.00X.1.730	D 845, H 52	LED	840	10400 lm	110 W	17,0	smart+free
Tunable White - 2700 K to 6500 K							
312301.00X.2.76	D 845, H 52	LED	827-865	6900 lm	76 W	15,8	DALI
312301.00X.2.730	D 845, H 52	LED	827-865	6900 lm	76 W	15,8	smart+free
Diameter D 1009 mm, Canopy Ø 263 mm, h 40 mm							
312304.00X.76	D 1009, H 52	LED	830	11900 lm	122 W	16,9	DALI
312304.00X.730	D 1009, H 52	LED	830	11900 lm	122 W	16,9	smart+free
312304.00X.1.76	D 1009, H 52	LED	840	12400 lm	122 W	17,1	DALI
312304.00X.1.730	D 1009, H 52	LED	840	12400 lm	122 W	17,1	smart+free
Tunable White - 2700 K to 6500 K							
312304.00X.2.76	D 1009, H 52	LED	827-865	7450 lm	85 W	15,1	DALI
312304.00X.2.730	D 1009, H 52	LED	827-865	7500 lm	85 W	15,2	smart+free

Light colour 827 on request.



Diffuser plastic (PMMA)
opal/microprismatic

TRIONA®

Product overview | Pendant luminaires



Pendant luminaires | Triona FerroMurano

Type of Protection: IP 20
 Protection Class: I
 Impact Protection: IK03
 Suspension Length: 500-1200 mm

Cover: sheet steel, powder-coated. Frame: aluminium, powder-coated. Lateral light emission for direct illumination through handmade FerroMurano coloured glass. Indirect light emission through non-yellowing plastic (PMMA) diffuser, satin finish. Canopy: aluminium, powder-coated, 3-point steel cable suspension, steplessly adjustable. Special lengths available on request. Integral driver.

Available colours (X): 2 = white, 31 = anthracite metallic, 4 = silver metallic

Versions with smart+free Bluetooth® control for wireless network and operation using Android / iOS devices, free app available for download.

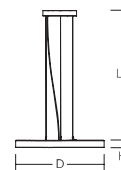

Reference number	Dimensions	Lamp	Light colour	Luminous flux	System power	dim-able
------------------	------------	------	--------------	---------------	--------------	----------

Pendant luminaires - Direct light emission

Price Category 21



Glass FerroMurano red

Diameter D 461 mm, Canopy Ø 263 mm, h 40 mm

312414.00X.76	D 461, H 52	LED	830	1900 lm	30 W	DALI
312414.00X.730	D 461, H 52	LED	830	1900 lm	30 W	smart+free
312414.00X.1.76	D 461, H 52	LED	840	1950 lm	30 W	DALI
312414.00X.1.730	D 461, H 52	LED	840	1950 lm	30 W	smart+free

Diameter D 681 mm, Canopy Ø 263 mm, h 40 mm

312358.00X.76	D 681, H 52	LED	830	3850 lm	57 W	DALI
312358.00X.730	D 681, H 52	LED	830	3850 lm	57 W	smart+free
312358.00X.1.76	D 681, H 52	LED	840	4000 lm	57 W	DALI
312358.00X.1.730	D 681, H 52	LED	840	4000 lm	57 W	smart+free

Glass FerroMurano blue

Diameter D 461 mm, Canopy Ø 263 mm, h 40 mm

312415.00X.76	D 461, H 52	LED	830	2150 lm	30 W	DALI
312415.00X.730	D 461, H 52	LED	830	2150 lm	30 W	smart+free
312415.00X.1.76	D 461, H 52	LED	840	2250 lm	30 W	DALI
312415.00X.1.730	D 461, H 52	LED	840	2250 lm	30 W	smart+free

Diameter D 681 mm, Canopy Ø 263 mm, h 40 mm

312359.00X.76	D 681, H 52	LED	830	4700 lm	57 W	DALI
312359.00X.730	D 681, H 52	LED	830	4700 lm	57 W	smart+free
312359.00X.1.76	D 681, H 52	LED	840	4900 lm	57 W	DALI
312359.00X.1.730	D 681, H 52	LED	840	4900 lm	57 W	smart+free

Glass FerroMurano white

Diameter D 461 mm, Canopy Ø 263 mm, h 40 mm

312413.00X.76	D 461, H 52	LED	830	2400 lm	30 W	DALI
312413.00X.730	D 461, H 52	LED	830	2400 lm	30 W	smart+free
312413.00X.1.76	D 461, H 52	LED	840	2500 lm	30 W	DALI
312413.00X.1.730	D 461, H 52	LED	840	2500 lm	30 W	smart+free

Diameter D 681 mm, Canopy Ø 263 mm, h 40 mm

312357.00X.76	D 681, H 52	LED	830	5350 lm	57 W	DALI
312357.00X.730	D 681, H 52	LED	830	5350 lm	57 W	smart+free
312357.00X.1.76	D 681, H 52	LED	840	5550 lm	57 W	DALI
312357.00X.1.730	D 681, H 52	LED	840	5550 lm	57 W	smart+free

Reference number	Dimensions	Lamp	Light colour	Luminous flux	System power	dimmi-able
------------------	------------	------	--------------	---------------	--------------	------------



Pendant luminaires - Direct 70% - indirect 30% light emission

Price Category 21

Glass FerroMurano red

Diameter D 461 mm, Canopy Ø 263 mm, h 40 mm

312417.00X.76	D 461, H 52	LED	830	2450 lm	40 W	DALI
312417.00X.730	D 461, H 52	LED	830	2450 lm	40 W	smart+free
312417.00X.1.76	D 461, H 52	LED	840	2550 lm	40 W	DALI
312417.00X.1.730	D 461, H 52	LED	840	2550 lm	40 W	smart+free

Diameter D 681 mm, Canopy Ø 263 mm, h 40 mm

312294.00X.76	D 681, H 52	LED	830	4300 lm	68 W	DALI
312294.00X.730	D 681, H 52	LED	830	4300 lm	68 W	smart+free
312294.00X.1.76	D 681, H 52	LED	840	4450 lm	68 W	DALI
312294.00X.1.730	D 681, H 52	LED	840	4450 lm	68 W	smart+free

Glass FerroMurano blue

Diameter D 461 mm, Canopy Ø 263 mm, h 40 mm

312418.00X.76	D 461, H 52	LED	830	2800 lm	40 W	DALI
312418.00X.730	D 461, H 52	LED	830	2800 lm	40 W	smart+free
312418.00X.1.76	D 461, H 52	LED	840	2950 lm	40 W	DALI
312418.00X.1.730	D 461, H 52	LED	840	2950 lm	40 W	smart+free

Diameter D 681 mm, Canopy Ø 263 mm, h 40 mm

312295.00X.76	D 681, H 52	LED	830	5150 lm	68 W	DALI
312295.00X.730	D 681, H 52	LED	830	5150 lm	68 W	smart+free
312295.00X.1.76	D 681, H 52	LED	840	5350 lm	68 W	DALI
312295.00X.1.730	D 681, H 52	LED	840	5350 lm	68 W	smart+free

Glass FerroMurano white

Diameter D 461 mm, Canopy Ø 263 mm, h 40 mm

312416.00X.76	D 461, H 52	LED	830	3150 lm	40 W	DALI
312416.00X.730	D 461, H 52	LED	830	3150 lm	40 W	smart+free
312416.00X.1.76	D 461, H 52	LED	840	3300 lm	40 W	DALI
312416.00X.1.730	D 461, H 52	LED	840	3300 lm	40 W	smart+free

Diameter D 681 mm, Canopy Ø 263 mm, h 40 mm

312293.00X.76	D 681, H 52	LED	830	5850 lm	68 W	DALI
312293.00X.730	D 681, H 52	LED	830	5850 lm	68 W	smart+free
312293.00X.1.76	D 681, H 52	LED	840	6000 lm	68 W	DALI
312293.00X.1.730	D 681, H 52	LED	840	6000 lm	68 W	smart+free

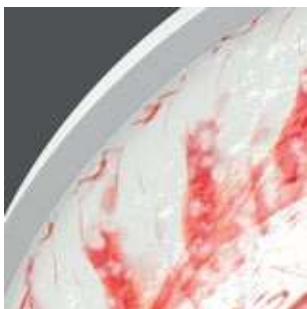

Glass FerroMurano red

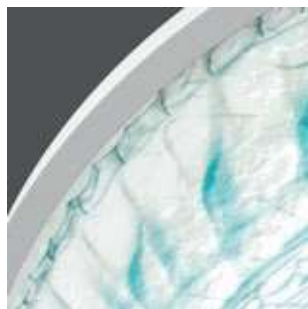

Glass FerroMurano blue



Glass FerroMurano white

TRIONA®

Murano glass

A VENETIAN LEGEND

The Venetian art of glassmaking is considered legendary to this day. Pioneers of this craft, like the world famous company Ferro from Murano, have been keeping this tradition carefully over many generations and share their know-how advisedly selected. The cooperation of the old master Guido Ferro and RZB unite the Venetian art of glassmaking and the high standards in design and technology of RZB; it is cross-border appreciation and synergy at the same time. The result is a liaison between glass and light that definitely can be regarded as epic work.

More than 700 years of craftsmanship, tradition and passion "a la Ferro" make each of the mouth-blown glass panels an individual item of touching beauty. Each millimetre of this "levitating" circle is steeped in light; the seamless, almost playful colouring of the Murano glass is brought to life in a fascinating way. Great designing skills, construction expertise that has been perfected over decades and pathbreaking LED technology were required to create such even light control and luminance. Through this, the quality and substance of RZB LUMINAIRES FerroMurano are rationally explained - but not its almost magic aesthetics. It remains a secret.

Each legend lives through one...

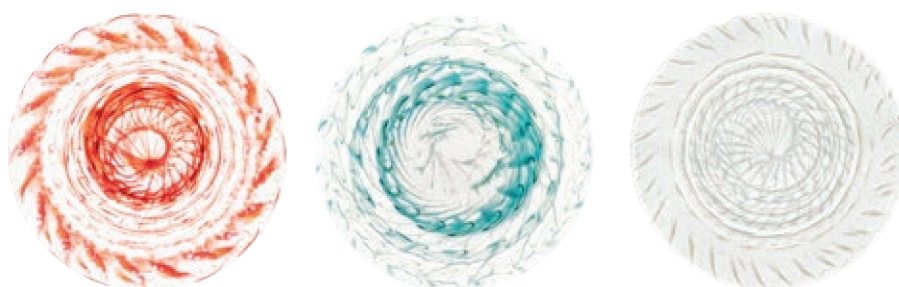
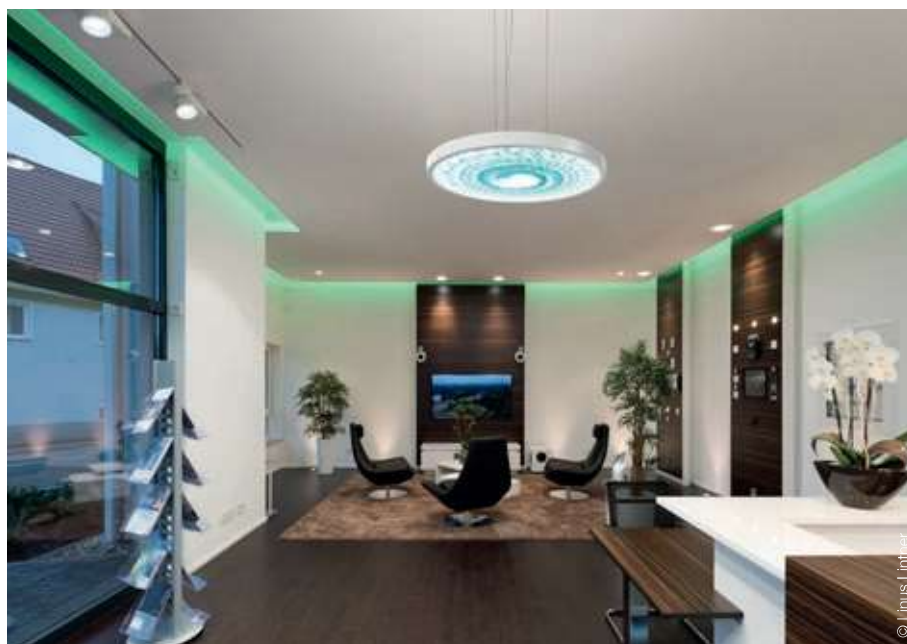

FURTHER LUMINAIRES, MATCHING THIS SERIES:



⊕ Sidelite® Round



⊕ Sidelite® Round



⊕ Flat Slim



⊕ Ring of fire®

LIGHT MANAGEMENT SYSTEMS, MATCHING THIS SERIES:

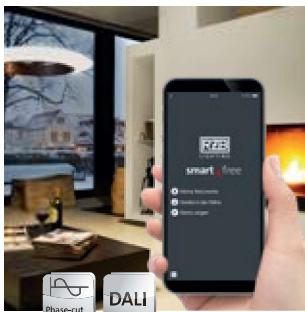

⊕ smart+free
Bluetooth®

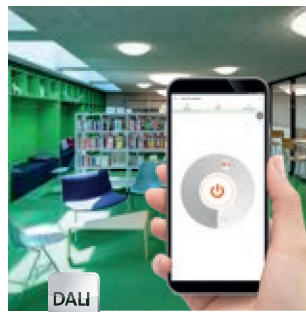

⊕ light control +³ Economy
Bluetooth®

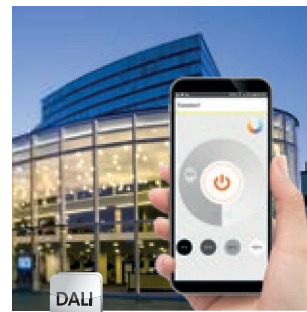

⊕ light control +³ Professional
WLAN

HIGHEST PRODUCT AND CONSULTING QUALITY

⊕ RELIABILITY

We are your reliable partner. From the first idea to the implementation and far beyond, we accompany your project. Personal, passionate and individual. Thanks to our excellent expertise, top product quality and services such as lighting design, economic efficiency analysis and commissioning, we meet the high demands of all parties involved in the planning process.

- ✓ availability of BIM files
- ✓ easy and quick installation
- ✓ quality and long warranty

⊕ WARRANTY

RZB grants 5 years warranty on LED luminaires and 2 years warranty on emergency luminaires!

The creation of high quality lighting solutions is our passion. Our products are developed and manufactured with the utmost care.

In addition to SMART TECHNOLOGY and EXCELLENT DESIGN, we are dedicated to manufacture luminaires of highest quality throughout the entire value chain through to After Sales Service.

Because of this, we confidently grant you a 5 years warranty on LED luminaires and 2 years warranty on emergency luminaires with effect of the date of invoice without prior registration of your project.

Warranty terms to be found under
rzb.de/en/service/led-luminaire-warranty

RZB - FOR A TANGIBLE ADDED VALUE.



RZB
Rudolf Zimmermann,
Bamberg GmbH

Rheinstr. 16
96052 Bamberg
Germany

Phone +49 951/79 09-374
Fax +49 951/79 09-212

www.rzb-lighting.com
export@rzb.eu

